

OUTDOOR

OUTDOOR

OUTDOOR

01

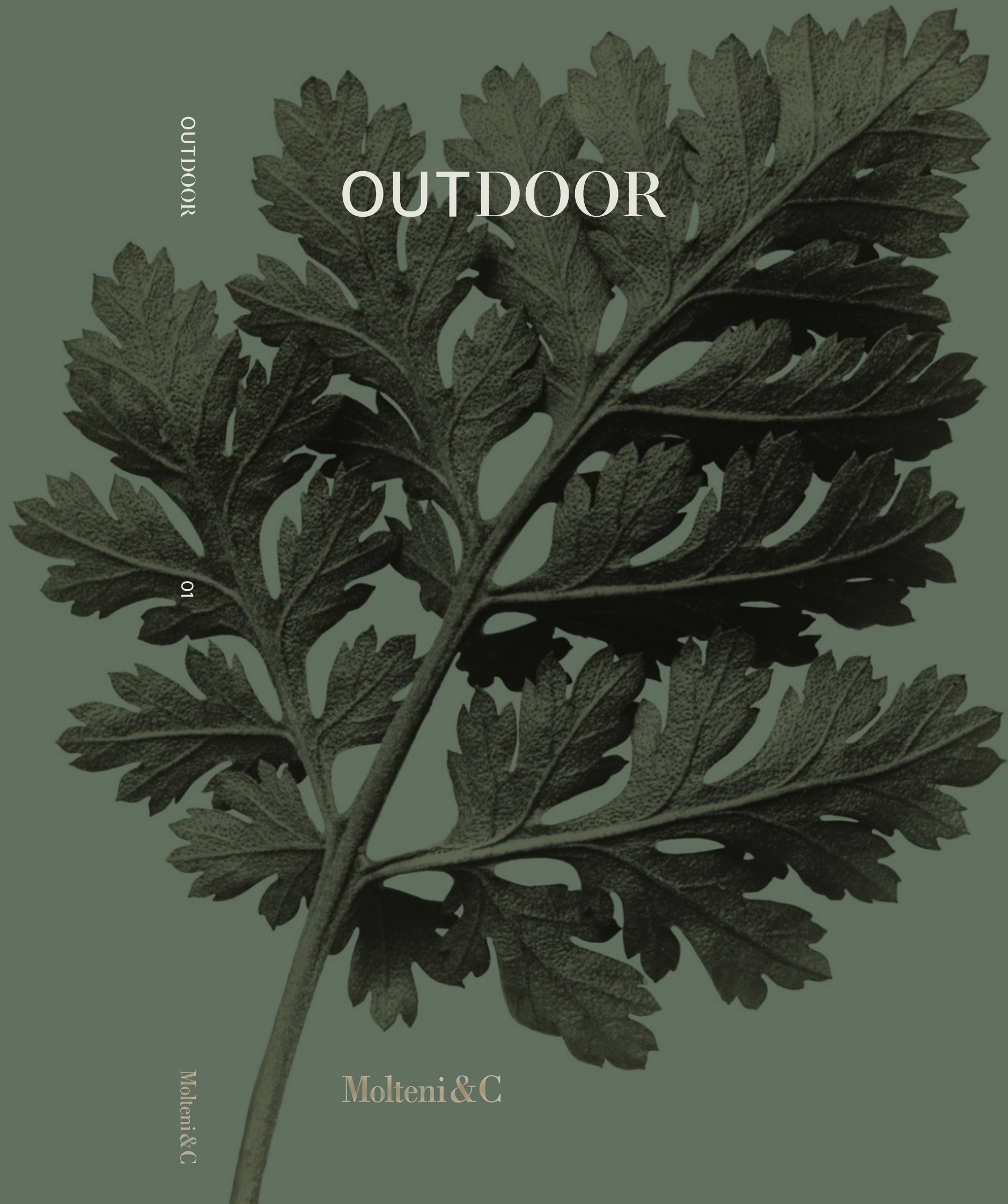

Outdoor

Molteni & C | OUTDOOR

The Outdoor Collection

“Feeling embraced by Italian savoir faire and inspired by what surrounds us.”

Vincent Van Duysen

Nature is an important part of our life: a connection that aims to rediscover the lost time of seasons and colours, and the pleasure of outdoor living, accompanied by furniture and objects designed especially for welcoming spaces. A freedom that has never been yearned for as much before now, a sensitivity - for living *en plein air* - that is closely related to respect for nature and the concept of sustainability. The new Outdoor proposal draws its inspiration from the exclusivity of refined Italian excellence. These are also characteristics of the creative universe of artistic director Vincent Van Duysen, who has coordinated two extensive collections that mark Molteni&C's important debut in outdoor furniture. This is a natural consequence of the company's journey into the art of living. The products are interpreted by the most important contemporary designers, from Foster + Partners to Ron Gilad, from Gio Ponti to artistic director Vincent Van Duysen.

“For a new idea of outdoor furniture, because it is based on cultural and design references from tradition,” Van Duysen points out, “but modern, characterised by an idea of simplicity that stems from careful plays on proportions. The technology is cutting-edge but hidden, the materials are natural, timeless. Characteristics that are intrinsic to Molteni&C's identity: the careful craftsmanship of the production, the sophistication of the details, the beauty of the individual objects that encapsulates the lessons of the great architects and designers it has interpreted. The new outdoor proposal shows a graphic presence and a sense of timelessness that I find in the brand”.

La natura è parte integrante del nostro modo di vivere: una connessione volta a ritrovare il tempo perduto delle stagioni e dei colori, riscoprire il vivere all'aria aperta, accompagnati da arredi e oggetti pensati per spazi accoglienti. Una libertà quanto mai ricercata, una sensibilità - quella del vivere *en plein air* - che ha molto a che fare con il rispetto per la natura e con il concetto di sostenibilità. La nuova proposta Outdoor trae ispirazione dall'esclusività dell'eccellenza italiana, ricercata e raffinata. Caratteristiche proprie anche dell'universo creativo del direttore artistico Vincent Van Duysen, che ha coordinato due ampie collezioni che segnano l'importante debutto di Molteni&C nell'arredo per esterno. Una naturale conseguenza del percorso dell'azienda nell'arte del vivere. I prodotti sono interpretati dai più importanti designer contemporanei, da Foster + Partners a Ron Gilad, da Gio Ponti al direttore artistico Vincent Van Duysen.

“Per una nuova idea di arredo da esterno, perché fondato su riferimenti culturali e progettuali della tradizione”, precisa Van Duysen, “ma moderno, caratterizzato da un'idea di semplicità che nasce da attenti giochi di proporzioni. La tecnologia è all'avanguardia ma nascosta, i materiali sono naturali, senza tempo. Caratteristiche proprie dell'identità di Molteni&C: l'accurato artigianato produttivo, la sofisticatezza dei dettagli, la bellezza dei singoli oggetti che racchiude in sé le lezioni dei grandi architetti e designer di cui è stata interprete. La nuova proposta outdoor mostra una presenza grafica e un senso di atemporalità che ritrovo nel brand”.





Landmark, the collection characterised by solid teak, is harmoniously designed to allow outdoor spaces to be experienced with comfort and elegance, expressing itself through a material and emotional character. It is a true milestone, a reverence that enhances Molteni&C's mastery in magnify natural elements into furniture with timeless appeal. The Palinfrasca sofa and armchair, based on Luca Meda's 1994 project, recall the brilliant mind concealed by light-hearted veils, inspiring the union of poles and branches [pali e frasche] in a basket, representing a safe and intimate place. A voluptuous weave that becomes a founding structure, dynamic and fluid.

The **Timeout Collection**, instead, features metal as the predominant material. A reference to modernist architecture, where the apparently cold character is mitigated by its fine lines. A contemporary interpretation of bronzed metal, softened by the intertwined ropes of the backrests or the natural materials of the various elements.

Weaving the story of a suspended and regained atmosphere, where time becomes a well-deserved reconciliation break with outdoor spaces, to be experienced with extreme freedom and versatility.

A range of products that refer to natural places where the city becomes a mere outline.

Molteni&C's two outdoor collections are independent but dialogue with each other, thanks to mutual and sophisticated references in the details and in the common colour palette, which reflects typically Mediterranean colours, from the warm earthy tones to the hues of olive groves, to the shades of coastal vegetation: olive green, anthracite, ivory, burnished and desert yellow. The same shades are featured in the carpets: creations by Marta Ferri, Nicola Gallizia and Vincent Van Duysen add an extra touch of elegance to the outdoor experience.

To enrich the outdoor proposal, a series of timeless elements with a common charm, such as the **Arc** table of Foster+Partners or the **Panna Cotta** coffee table by Ron Gilad.

Two important projects join the **Heritage Collection**: great classics, expressions of extremely contemporary design ideas that the brand revives.

Landmark, la collezione caratterizzata dal massello in teak, è armonicamente studiata per permettere di vivere con comfort ed eleganza gli spazi esterni, esprimendosi attraverso un carattere materico ed emozionale. Una vera e propria pietra miliare, una reverenza che esalta la maestria di Molteni&C nel saper valorizzare gli elementi naturali in arredi dal fascino senza tempo. Il divano e la poltrona Palinfrasca, ispirati al progetto di Luca Meda del 1994, evocano la genialità che si cela tra i veli della spensieratezza, da cui ha origine l'unione di pali e frasche in una cesta, a rappresentare un luogo sicuro, intimo. Un intreccio voluttuoso che diventa struttura fondante, dinamica e fluida.

La **Collezione Timeout** è invece caratterizzata dal metallo come materiale predominante. Un richiamo alle architetture moderniste, dove il carattere apparentemente freddo viene addolcito dalle sue linee sottili. Un'interpretazione contemporanea del metallo bronzato, ingentilito dagli intrecci delle corde degli schienali o dai materiali naturali dei vari elementi.

Un weaving che tesse la storia di un'atmosfera sospesa e riacquistata, dove il tempo diventa una meritata pausa di riconciliazione con spazi esterni, da vivere con estrema libertà e versatilità.

Una rosa di prodotti che rimandano a luoghi naturali dove la città diviene mero contorno.

Le due collezioni outdoor di Molteni&C sono indipendenti ma dialogano tra di loro, grazie a reciproci e sofisticati richiami nei dettagli e nella palette cromatica comune, che riporta a colori tipicamente mediterranei, dai toni caldi della terra alle cromie degli uliveti, alle gradazioni della vegetazione litoranea: verde oliva, antracite, avorio, brunito e giallo deserto. Le stesse tonalità vengono proposte nei tappeti: creazioni firmate da Marta Ferri, Nicola Gallizia e Vincent Van Duysen, regalano un ulteriore tocco di eleganza all'esperienza outdoor.

Ad impreziosire la proposta Outdoor, una serie di elementi comuni dal fascino senza tempo come il tavolo **Arc** di Foster + Partners o il tavolino **Panna Cotta** di Ron Gilad, appositamente studiato per essere esposto all'esterno.

Si aggiungono inoltre due importanti progetti di Gio Ponti, che arricchiscono l'**Heritage Collection**: grandi classici, espressione di idee progettuali di estrema contemporaneità.

LANDMARK COLLECTION

Landmark takes shape from fluid, organic lines and the distinct materiality of the elements. A design without corners, characterised by the woven teak wood motif that circumscribes the back, embracing the material with comfort and design. Everything is softened and cosy: the furnishings are soft to the touch, the structures have no edges, even in the connections between seat and supportive frame.

The wooden elements are rich in details, curves and joints of high cabinet making, thus enhancing their sculptural forms. They reflect Molteni&C's DNA, which stems precisely from the working of wood, here reinterpreted through a design that is able to express the wisdom and skill of tradition with a contemporary aesthetic language, drawing inspiration from the lessons of the protagonists of architecture who have worked with the Company in interpreting wood. Like Luca Meda, to whom homage is paid with the production of *Palinfrasca*, the sofa inspired by a 1994 work by the architect.

Landmark hosts a significant number of elements, including sofas, end pieces, chaise longues, a circular and a square 'love seat', and an armchair, accompanied by a large set of cushions - which can be easily combined in different configurations for different moments of conviviality: from lounge settings to more traditional living spaces.

The banded weave of the back is the distinctive element of the collection: the ribbon, available in both natural teak and olive green EVA polyurethane (leather effect), represents the rhythm that orchestrates the various furnishings of the series, and recalls the dimensions of Timeout.

The seat cushions are set into the solid teak frame. The proportions are calibrated and the lines of the upholstery clean, leaving room for the refinement of the weave. The thicknesses of the cushions are generous, for greater seating comfort and an evident material presence.

Although lightweight and removable, all seats are equipped with protective covers in water-repellent fabrics.

Landmark prende forma da linee fluide e organiche e dalla spiccata matericità degli elementi. Un disegno senza angoli, caratterizzato dal motivo intrecciato in legno di teak, che circonda lo schienale, per abbracciare con comfort e design. Tutto è ingentilito e accogliente: gli arredi sono morbidi al tatto, le strutture prive di spigoli, perfino nei raccordi tra seduta e struttura portante.

Gli elementi in legno sono ricchi di dettagli, curvature e incastri di alta ebanisteria, risaltandone così le forme scultoree. Rispecchiano il dna di Molteni&C che nasce proprio dalla lavorazione del legno in essenza, qui riletto attraverso un design che sa interpretare la sapienza e la maestria della tradizione con un linguaggio estetico attuale, traendo spunto dalla lezione dei protagonisti dell'architettura che hanno interpretato il legno insieme all'Azienda. Come Luca Meda, al quale viene reso omaggio con la produzione di *Palinfrasca*, il divano che trae ispirazione proprio da un'opera del 1994 firmata dall'architetto.

Landmark è composta da un significativo numero di elementi, tra cui divani, terminali, chaise longue, una "love seat" circolare e una quadrata, e una poltrona, corredati da un ampio set di cuscini - che possono essere facilmente accostati in configurazioni sempre diverse per differenti momenti di convivialità: da ambienti lounge fino a living più tradizionali.

L'intreccio a fasce dello schienale è l'elemento distintivo della collezione: la fettuccia, disponibile sia in teak al naturale sia in poliuretano EVA verde oliva (effetto cuoio), oltre a rappresentare il ritmo che orchestra i vari arredi della serie, richiama dimensionalmente Timeout.

I cuscini di seduta sono incastonati nella struttura in massello di teak. Le proporzioni sono calibrate e le linee del rivestimento pulite, per lasciare spazio alla raffinatezza dell'intreccio. Gli spessori delle cuscinate sono generosi, per un maggiore comfort di seduta e una presenza materica evidente.

Nonostante siano leggere e removibili, tutte le sedute sono fornite di teli di copertura protettivi in tessuti idrorepellenti.





Palinfrasca Sofas Phoenix Armchairs and coffee tables Regent Coffee tables Vincent Van Duysen



Palinfrasca Sofas Regent Coffee table Vincent Van Duysen

Palinfrasca Sofa **Phoenix** Armchairs and coffee table *Vincent Van Duysen*

Panna Cotta Coffee table *Ron Gilad*





Palinfrasca Sofa Phoenix Coffee table Vincent Van Duysen









Palinfrasca Sofas Phoenix Armchairs and coffee tables Regent Coffee tables Vincent Van Duysen











Phoenix Sofa and coffee table Palinfrasca Armchairs Regent Coffee table Boulogne Basket Vincent Van Duysen



HERITAGE COLLECTION

The outdoor proposal coordinated by Vincent Van Duysen is joined by two important projects by **Gio Ponti**, enriching Molteni&C's **Heritage Collection**: great classics, expressions of extremely contemporary design ideas that the brand revives.

Thus the iconic **D.154.2**, already in the indoor catalogue, finds a new identity and use in its outdoor version. The **D.150.5** solid wood chaise longue, designed by Gio Ponti for the cruise ship *Andrea Doria* in 1952, sees the light. A piece of furniture of great craftsmanship, it is evidence of Ponti's design vision. A complex product but meant for industrial production, because "*Industry is the way of the 20th century, it is its way of creating*" (Gio Ponti, 1925).

Alla proposta Outdoor coordinata da Vincent Van Duysen si aggiungono due importanti progetti di **Gio Ponti**, che arricchiscono l'**Heritage Collection** di Molteni&C: grandi classici, espressione di idee progettuali di estrema contemporaneità che il brand fa rivivere.

Così l'iconica **D.154.2**, già nel catalogo indoor, trova un'inedita identità e fruizione nella sua versione outdoor. Torna invece alla luce la chaise longue **D.150.5** in legno massello, progettata da Gio Ponti per la nave da crociera *Andrea Doria* nel 1952. Un arredo di grande maestria manifatturiera, testimonianza della visione progettuale di Ponti. Un prodotto complesso ma pensato per una produzione industriale, perché "*L'industria è la maniera del XX secolo, è il suo modo di creare*" (Gio Ponti, 1925).





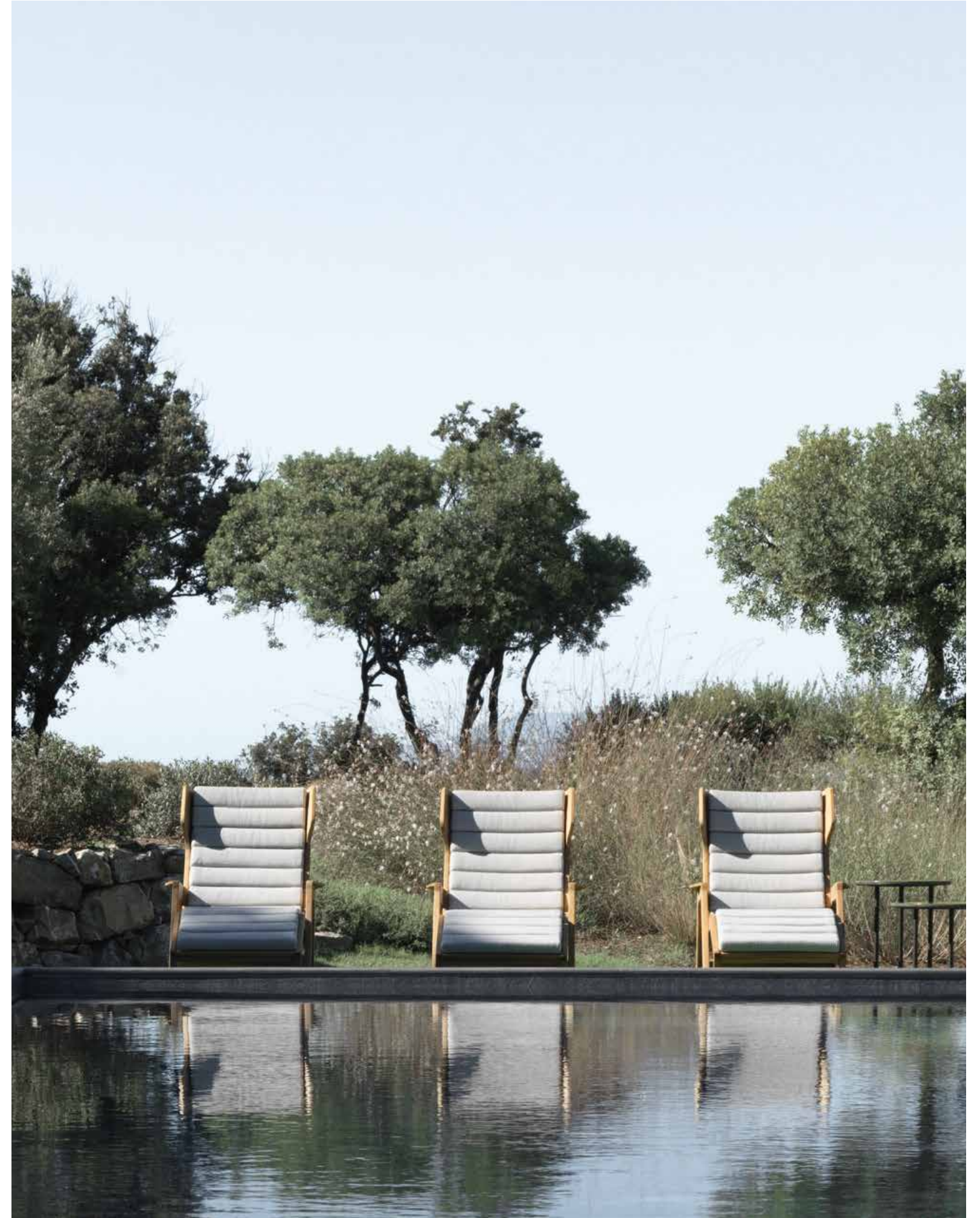







D.150.5 Armchair *Gio Ponti*



D.154.2 Armchairs *Gio Ponti*
Panna Cotta Coffee table *Ron Gilad*





Palinfrasca Sofa Regent Coffee tables Vincent Van Duysen
D.154.2 Armchairs Gio Ponti





A union between architecture and nature

"For me, Karl Blossfeldt's work represents an important link between architecture and nature. It is the same link that I wanted to include in the elements of this outdoor proposal.

His subjects - flowers, plants, botanical elements - are the perfect match to juxtapose with the furnishings of the two new collections. For the interpretation of this union, I decided to rely on the creative flair of the photographer Frederik Vercruysse, who, with his minimalist approach, has captured with great purity the organic and sinuous forms of the elements of the collections, which find a perfect match in the world of botany".

Vincent Van Duysen

Through his works, Karl Blossfeldt was able to transcend the medium of expression, rendering images that translate into a universal artistic language, where lines and shapes become a synthesis of expression and iconography.

Thanks to his meticulous talent, he managed to introduce the sculptural dimension into a typically two-dimensional art form such as photography, using the world of botany as his main subject.

Elegant, refined, contemplative; Blossfeldt's shots, in their immediate elegance, render unseen natural details that still today inspire awe and admiration in the beholder.

Nature, like architecture and every other art form, can educate us in beauty and interiority.

"If I give someone a horsetail, he will have no great difficulty making a photographic enlargement of it - anyone can do that. But to observe it, to notice and discover its forms, is something that only a few are capable of."

Karl Blossfeldt

"Il lavoro di Karl Blossfeldt rappresenta per me un legame importante tra architettura e natura. Lo stesso legame che ho voluto inserire negli elementi di questa proposta outdoor.

I suoi soggetti - fiori, piante, elementi botanici - sono l'abbinamento perfetto da giustapporre agli arredi delle due nuove collezioni. Per l'interpretazione di questo sodalizio, ho voluto affidarmi all'estro creativo del fotografo Frederik Vercruysse, che con il suo approccio minimalista, ha colto con grande purezza le forme organiche e sinuose degli elementi delle collezioni, che trovano un perfetto riscontro nel mondo della botanica".

Vincent Van Duysen

Karl Blossfeldt, tramite le sue opere, è stato in grado di trascendere il mezzo espressivo, restituendo immagini che si traducono in un linguaggio artistico universale, dove le linee e le forme diventano sintesi espressiva e iconografica.

Grazie al suo talento rigoroso, è riuscito ad introdurre la dimensione scultorea in una forma d'arte tipicamente bidimensionale come quella della fotografia, utilizzando il mondo della botanica come soggetto principale.

Eleganti, plastici, contemplativi; gli scatti di Blossfeldt nella loro immediata eleganza, restituiscono dettagli naturali mai visti, che ancora oggi creano stupore e ammirazione in chi li osserva.

La natura, come l'architettura e ogni altra forma d'arte, sono in grado di educarci alla bellezza e all'interiorità.

"Se do a qualcuno un equisetto, non avrà grandi difficoltà a fare una presa fotografica atta a supportare un'argomentazione; ma osservare, notare e scoprire le forme di quell'equiseto è qualcosa di cui solo pochi sono capaci."

Karl Blossfeldt



Karl Blossfeldt, *Silphium laciniatum*, before 1928

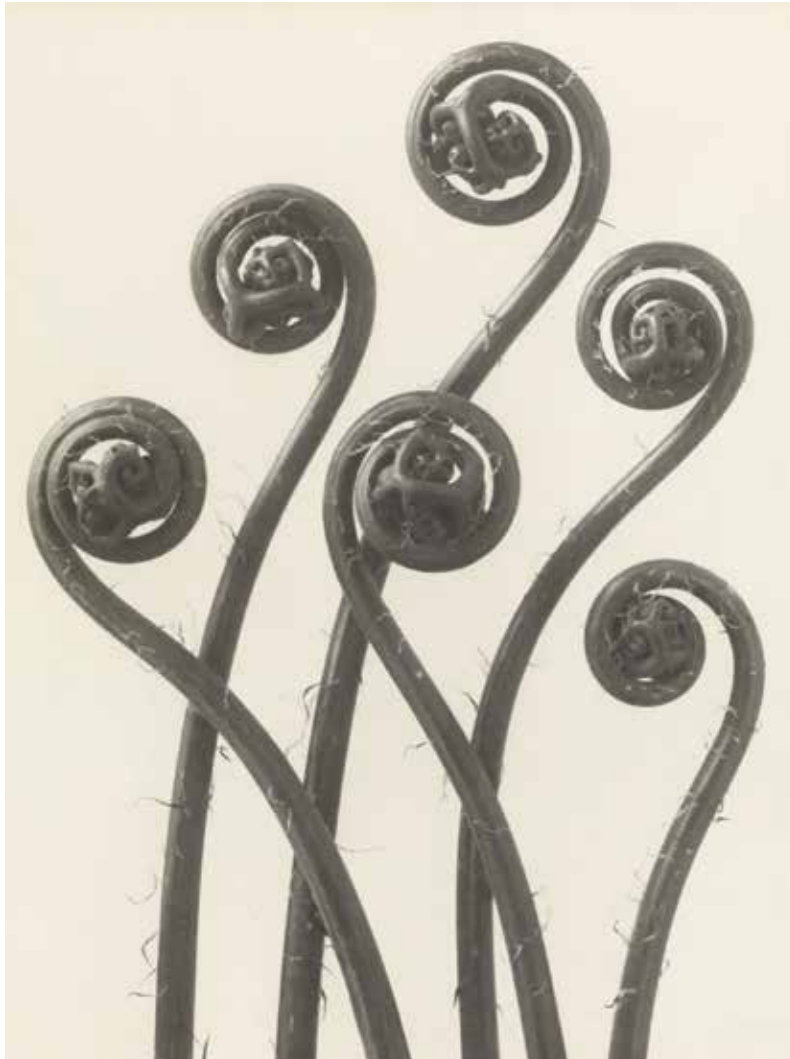

Karl Blossfeldt, *Adiantum pedatum*, before 1926



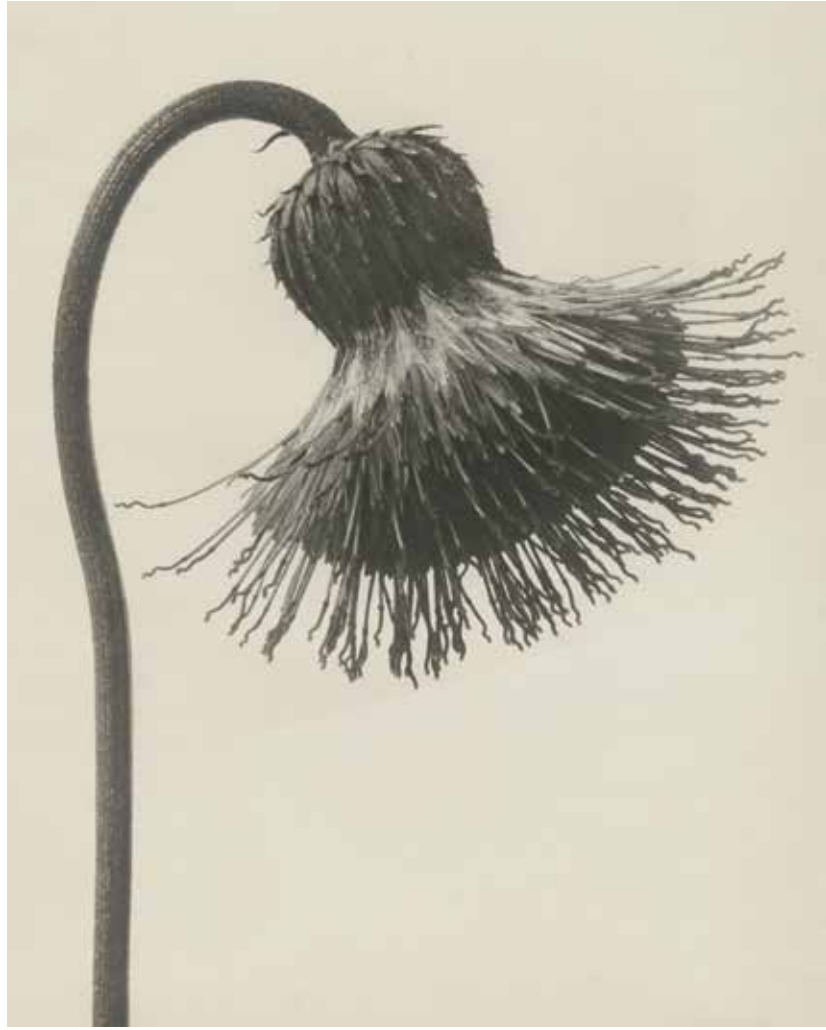

Karl Blossfeldt, *Cirsium canum*, before 1932





Karl Blossfeldt, *Eryngium bourgatii*, before 1928

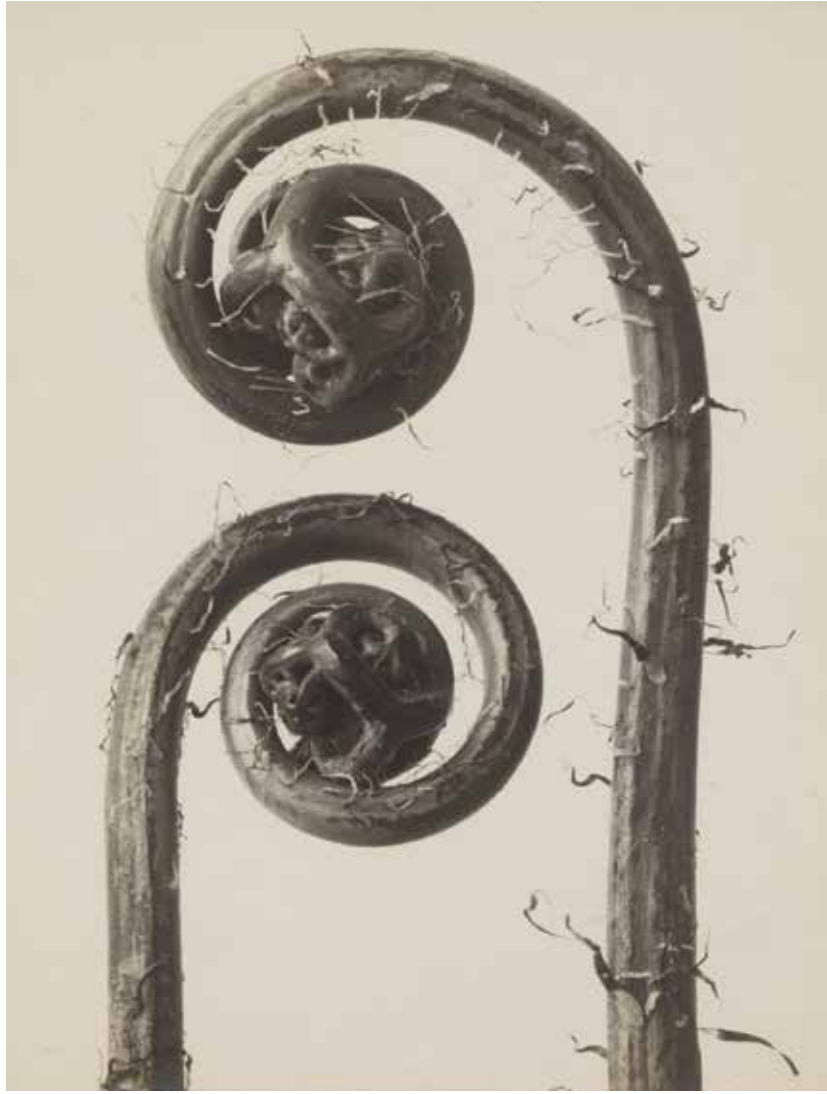

Karl Blossfeldt, *Adiantum pedatum*, before 1932





Karl Blossfeldt, *Chrysanthemum parthenium*, before 1928

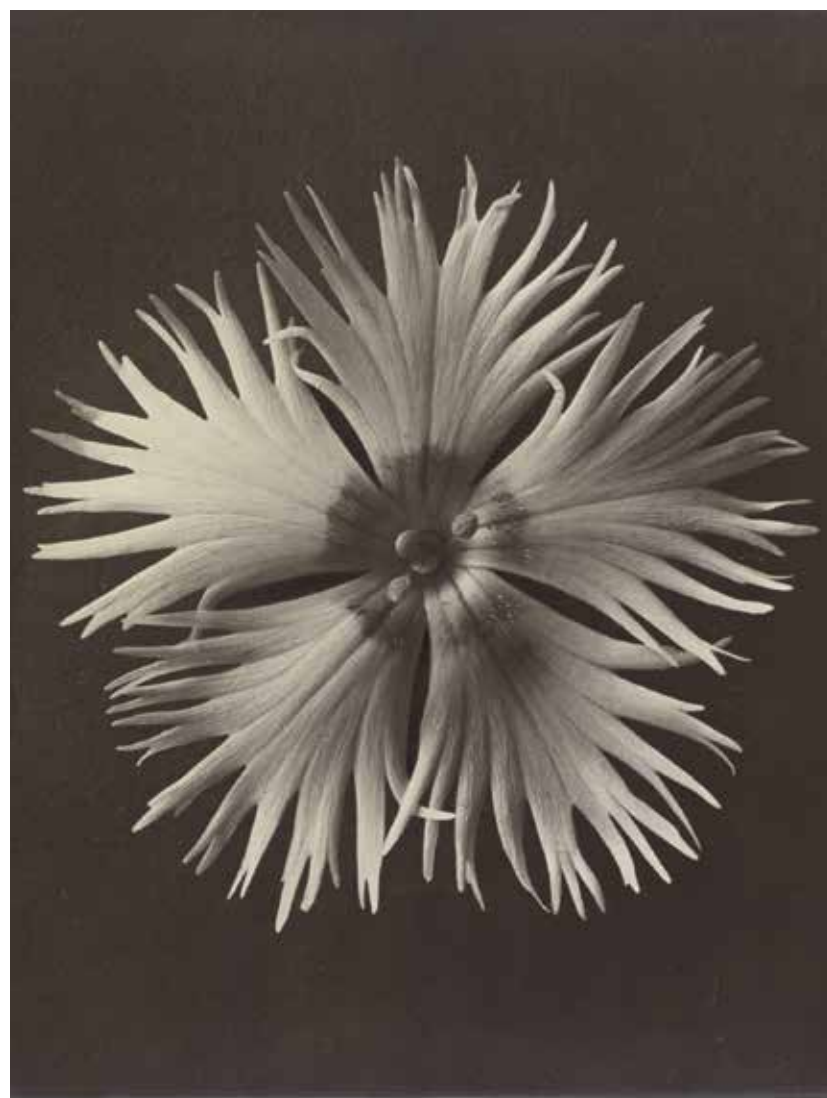

Karl Blossfeldt, *Dianthus plumarius*, before 1932







TIMEOUT COLLECTION

Timeout interpreta il tema del metallo, presentando in un modo moderno in un'ampia gamma di arredi, come: divano a due posti, poltrona con o senza braccioli, sedia con o senza braccioli, lettino, sgabello, panca, tavolino basso e tavolo da pranzo - per definire ambienti *plein air* o spazi tra in e outdoor.

Van Duysen trae ispirazione dalla tradizione del *fer forgé*, riservando al metallo un rigore formale e una purezza che rimanda a linguaggi eleganti e modernisti. La freddezza dell'alluminio è riscaldata dalla verniciatura color brunito, cromia che richiama il mondo naturale, come i marroni della terra, accesa da tonalità più calde.

La proposta si distingue per la fascia in alluminio che, piegandosi senza interrompersi, crea la struttura di sostegno, i braccioli e i piedini d'appoggio. Il tema dell'intreccio diventa nella parte metallica puramente evocativo: legato all'idea di movimento anziché alla mera forma, minimale senza perdere la sensualità materica. Il "weaving" diviene invece esplicito nel rivestimento della struttura, realizzato con un intreccio di nastri in fibra di polietilene.

Un intreccio minuto e fitto, capace di generare un contrasto efficace con l'essenzialità della parte di metallo. L'intreccio, eseguito magistralmente a mano, porta con sé anche quei valori di rarità e preziosità del saper fare artigianale.

La proposta si distingue per la fascia in alluminio che, piegandosi senza interrompersi, crea la struttura di sostegno, i braccioli e i piedini d'appoggio. Il tema dell'intreccio diventa nella parte metallica puramente evocativo: legato all'idea di movimento anziché alla mera forma, minimale senza perdere la sensualità materica. Il "weaving" diviene invece esplicito nel rivestimento della struttura, realizzato con un intreccio di nastri in fibra di polietilene.

Un intreccio minuto e fitto, capace di generare un contrasto efficace con l'essenzialità della parte di metallo. L'intreccio, eseguito magistralmente a mano, porta con sé anche quei valori di rarità e preziosità del saper fare artigianale.

Un intreccio minuto e fitto, capace di generare un contrasto efficace con l'essenzialità della parte di metallo. L'intreccio, eseguito magistralmente a mano, porta con sé anche quei valori di rarità e preziosità del saper fare artigianale.

Un intreccio minuto e fitto, capace di generare un contrasto efficace con l'essenzialità della parte di metallo. L'intreccio, eseguito magistralmente a mano, porta con sé anche quei valori di rarità e preziosità del saper fare artigianale.

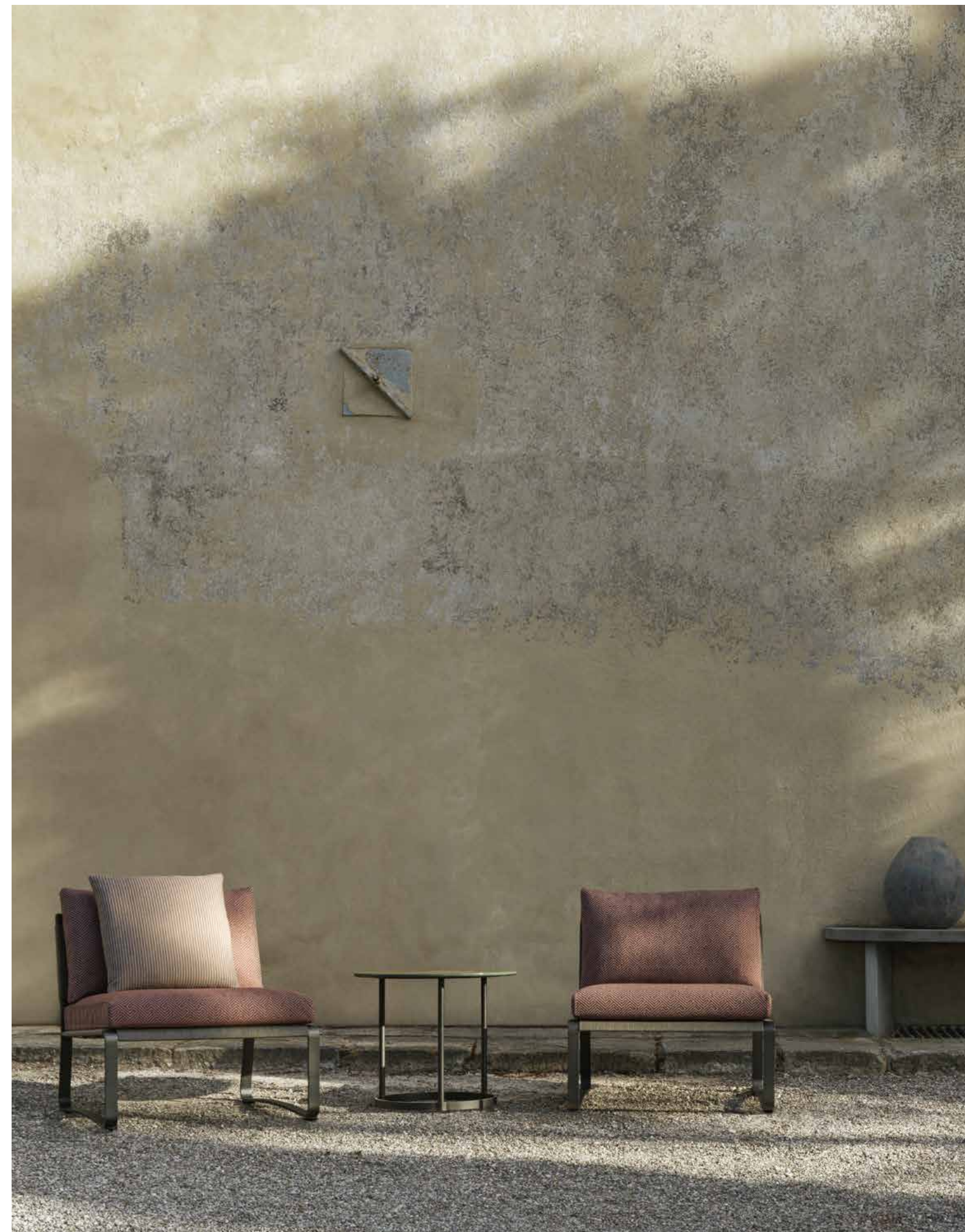





Phoenix Sofas, armchairs and coffee table Green Point Bench Vincent Van Duysen

Panna Cotta Coffee table Ron Gilad

Musco Carpet Marta Ferri



Phoenix Sofa and armchair Green Point Bench Vincent Van Duysen
Musco Carpet Marta Ferri











Phoenix Sofas, armchairs and coffee table *Vincent Van Duysen*

Panna Cotta Coffee table *Ron Gilad*

Palma Carpet *Nicola Gallizia*



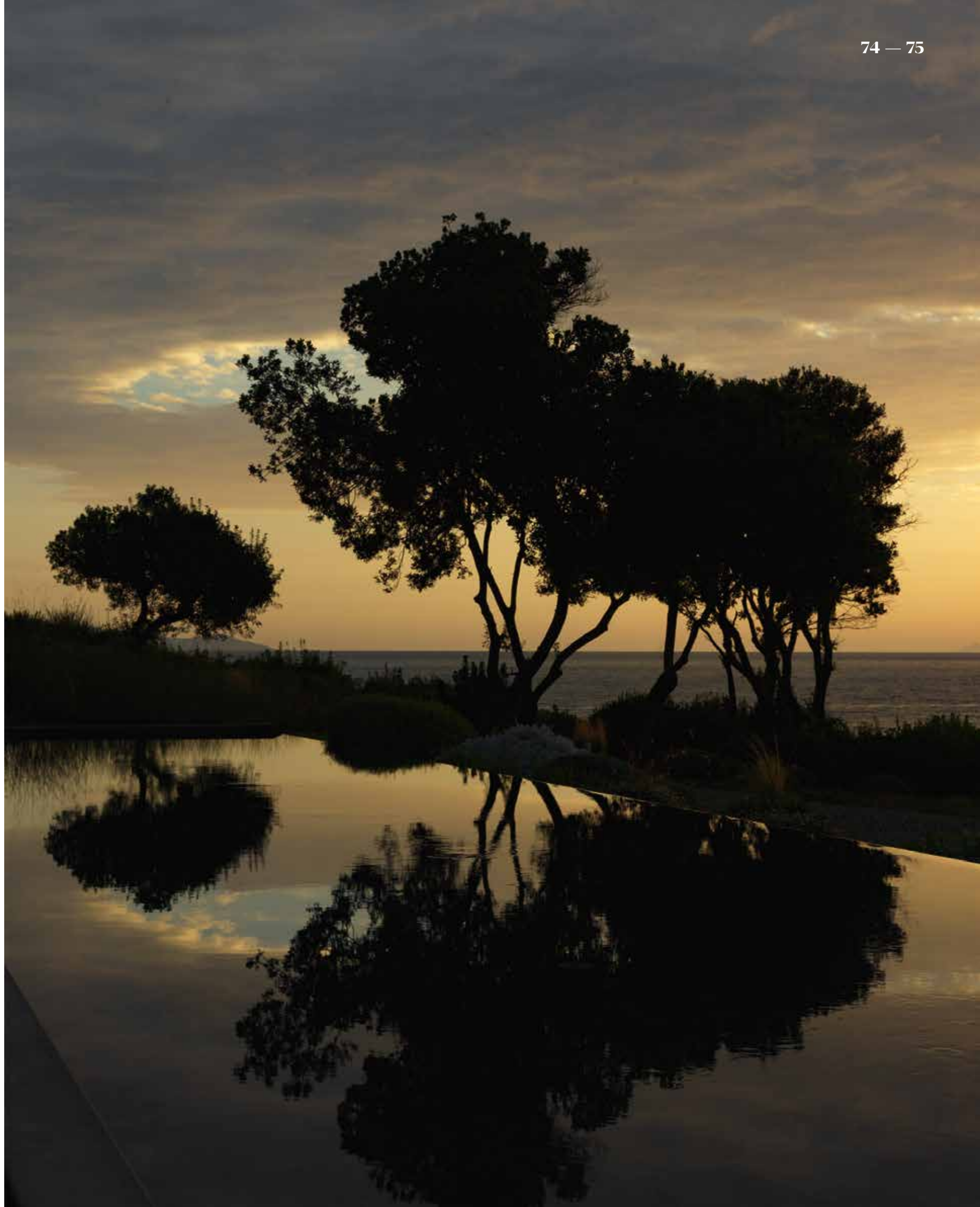



Phoenix Sofa and armchairs Regent Coffee tables Vincent Van Duysen



Arc Table *Foster + Partners*
Green Point Chair *Vincent Van Duysen*
Palma Carpet *Nicola Gallizia*



Hyde Pouff *Vincent Van Duysen*
Panna Cotta Coffee table *Ron Gilad*
Palma Carpet *Nicola Gallizia*









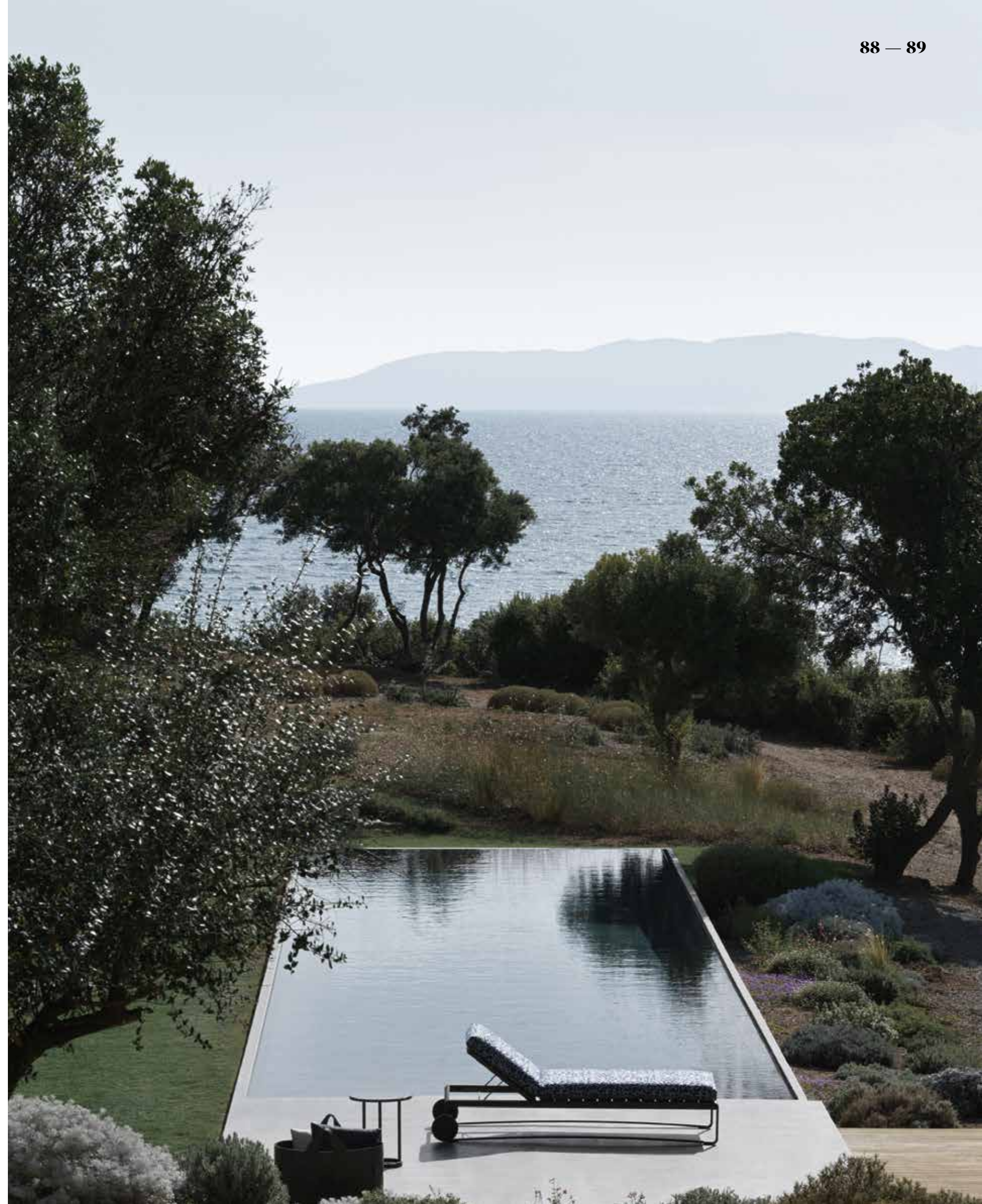



Guell Sunbed *Vincent Van Duysen*

Panna Cotta Coffee tables *Ron Gilad*





Phoenix Armchairs Regent Coffee tables Vincent Van Duysen









Golden Gate Table Green Point Chairs Hedera Carpet Vincent Van Duysen

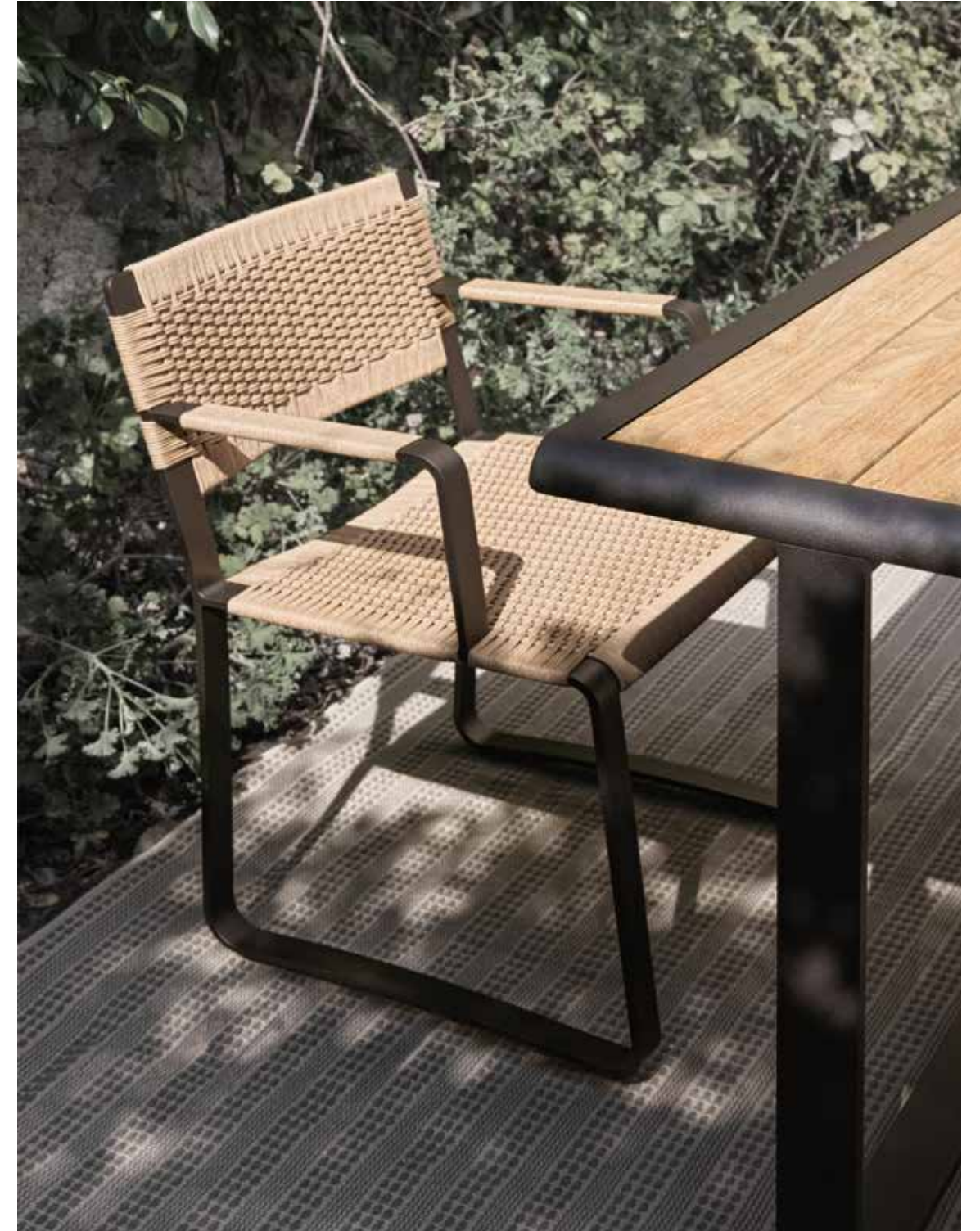

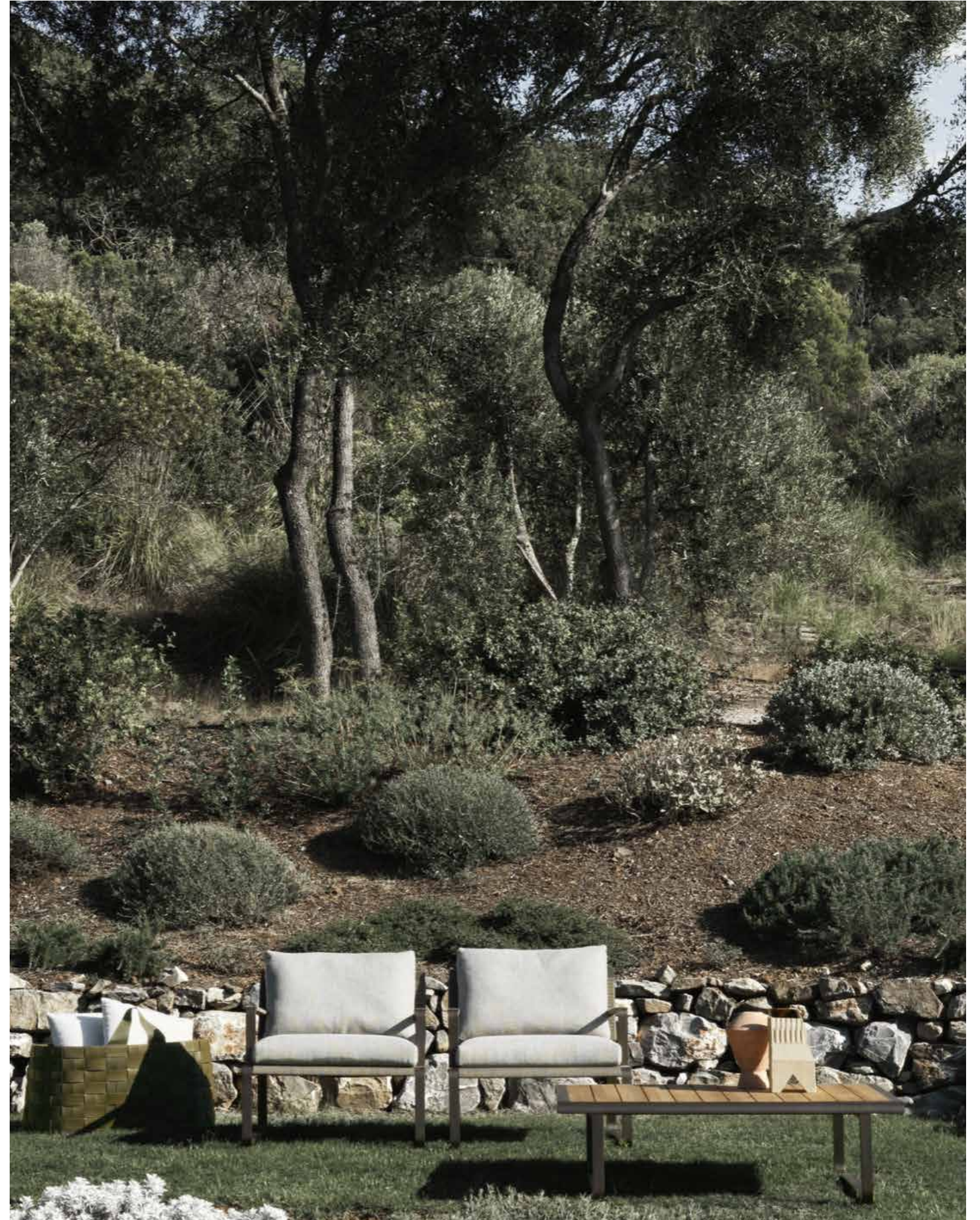

Phoenix Armchairs and coffee table Boulogne Basket Vincent Van Duysen



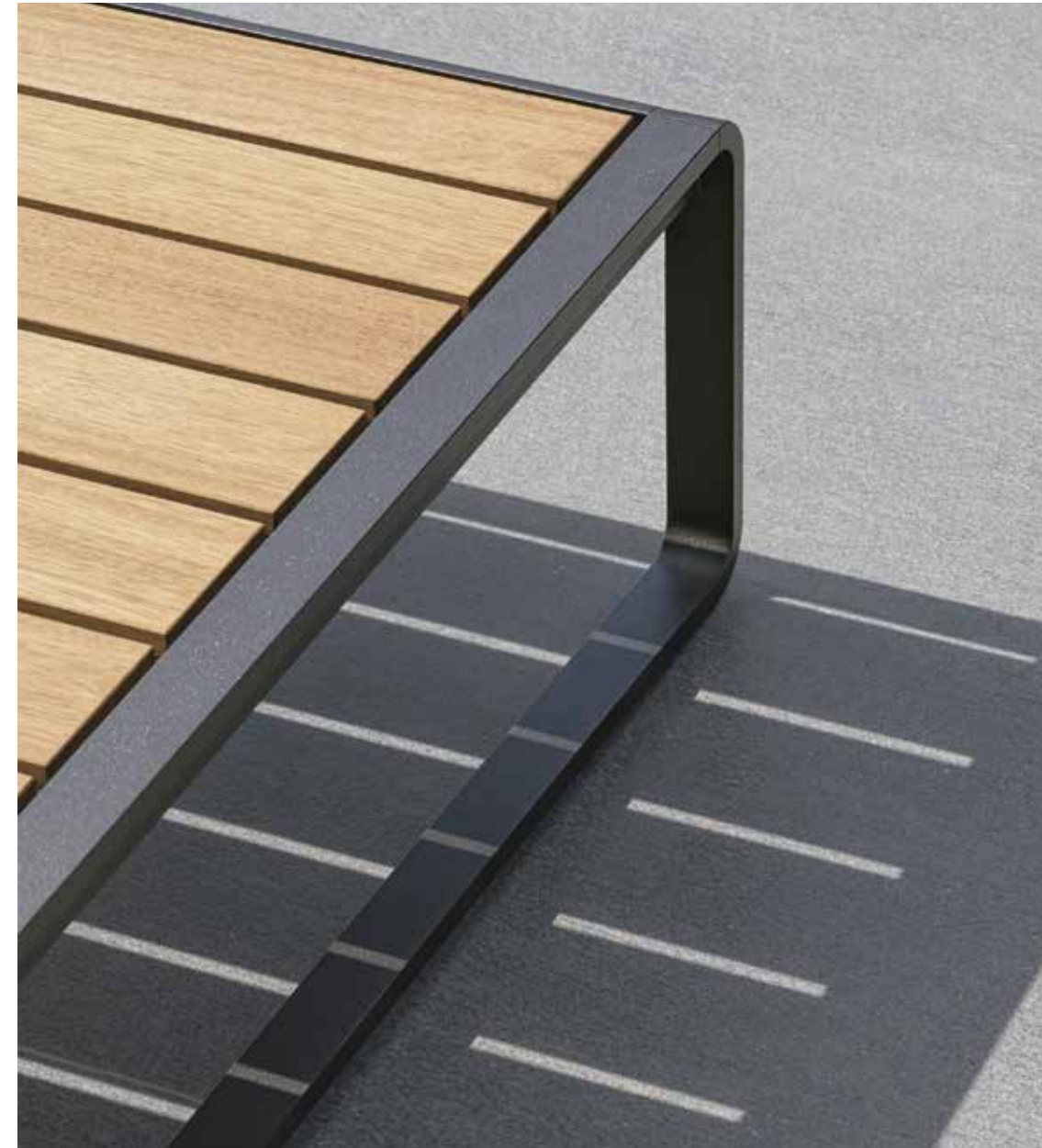



Gio Ponti / Heritage Collection



D150.5
armchair
Gio Ponti



D154.2
armchair
Gio Ponti

Landmark Collection



Palinfrasca
seating system
Vincent Van Duysen



Palinfrasca
armchair
Vincent Van Duysen



Palinfrasca
pouff
Vincent Van Duysen

Arc / Panna Cotta



Arc
table
Foster + Partners



Panna Cotta
coffee tables
Ron Gilad

Timeout Collection

Phoenix
sofa
Vincent Van Duysen



Phoenix
armchair
Vincent Van Duysen



Phoenix
coffee tables
Vincent Van Duysen



Phoenix
pouff
Vincent Van Duysen



Golden Gate
table
Vincent Van Duysen



Green Point
bench
Vincent Van Duysen



Green Point
chair
Vincent Van Duysen



Green Point
stool
Vincent Van Duysen



Timeout Collection

Carpet Collection



Guell
sunbed
Vincent Van Duysen



Regent
coffee tables
Vincent Van Duysen



Boulogne
baskets
Vincent Van Duysen



Hyde
pouff
Vincent Van Duysen

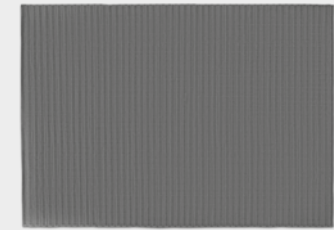

Hedera
Vincent Van Duysen

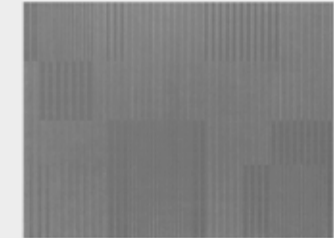

Palma
Nicola Gallizia

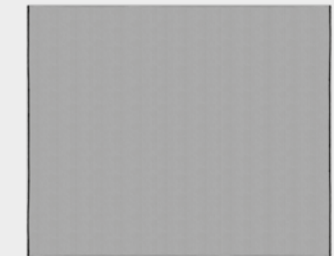

Musco
Marta Ferri

Heritage Collection

D.150.5 GIO PONTI

ARMCHAIR
POLTRONA

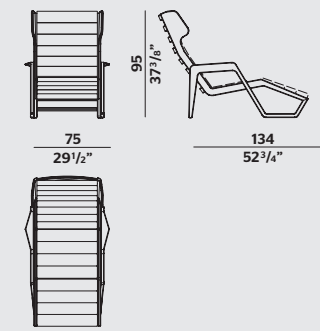

D.154.2 OUTDOOR GIO PONTI

ARMCHAIR
POLTRONA

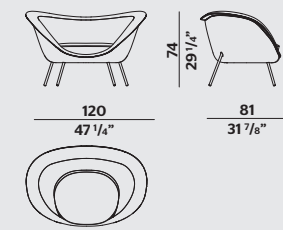

Landmark Collection

PALINFRASCA VINCENT VAN DUYSSEN

ARMCHAIR
POLTRONA

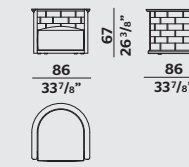

SOFA
DIVANO

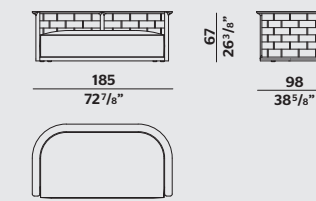

SOFA
DIVANO

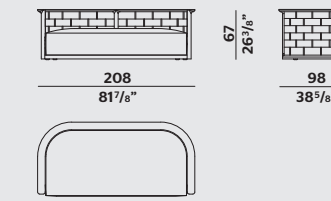

SOFA
DIVANO

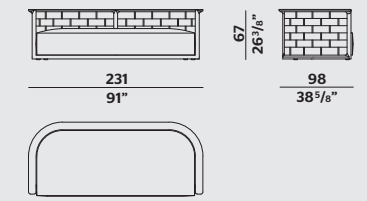

ISLAND
ISOLA

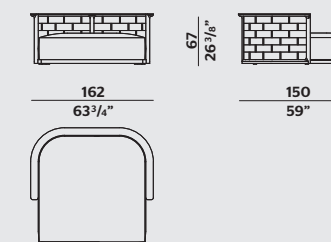

LOVE SEAT

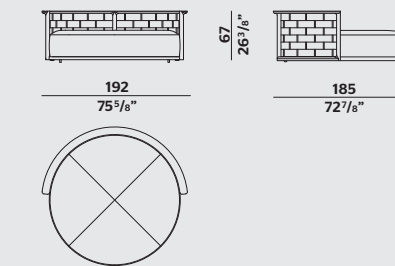

END ELEMENT
TERMINALE

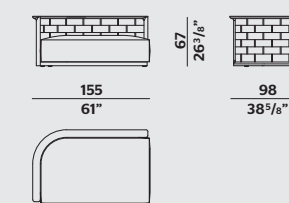

END ELEMENT
TERMINALE

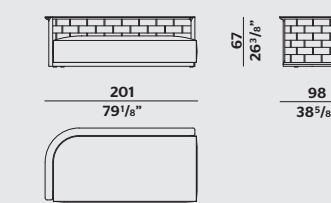

CHAISE LONGUE

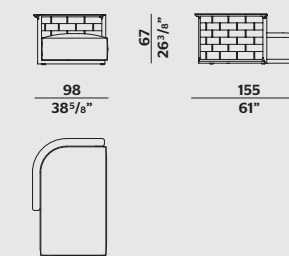

CHAISE LONGUE

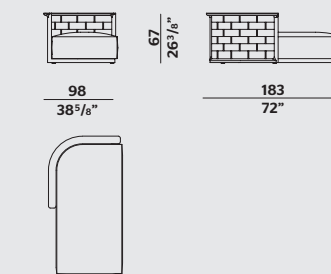

POUF

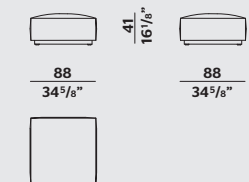

Timeout Collection

PHOENIX VINCENT VAN DUYSSEN

ARMCHAIR
POLTRONA

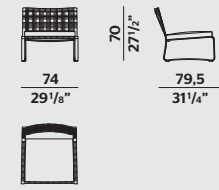

ARMCHAIR WITH ARMRESTS
POLTRONA CON BRACCIOLI

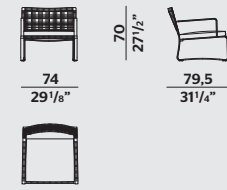

SOFA
DIVANO

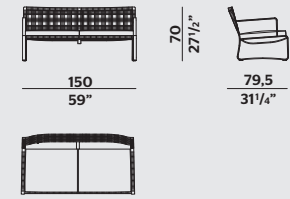

SOFA
DIVANO

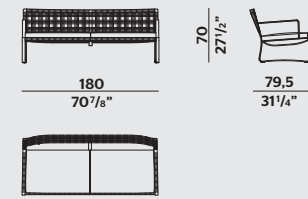

POUF

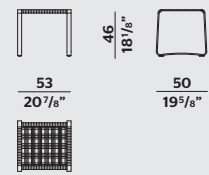

TEAK TOP COFFEE TABLE
TAVOLINO PIANO TEAK

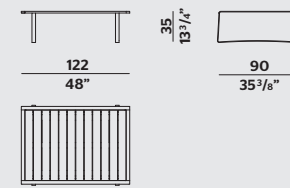

TEAK TOP COFFEE TABLE
TAVOLINO PIANO TEAK

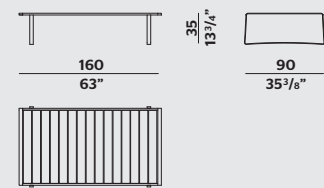

LAVA STONE TOP COFFEE TABLE
TAVOLINO PIANO PIETRA LAVICA

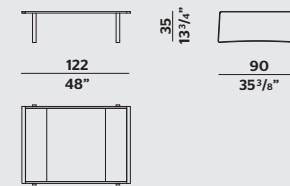

LAVA STONE TOP COFFEE TABLE
TAVOLINO PIANO PIETRA LAVICA

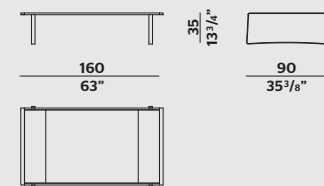

Timeout Collection

GOLDEN GATE VINCENT VAN DUYSSEN

TEAK TOP TABLE
TAVOLO PIANO TEAK

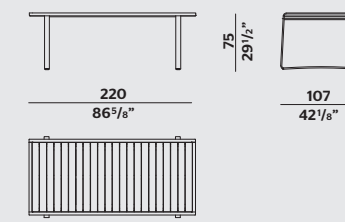

TEAK TOP TABLE
TAVOLO PIANO TEAK

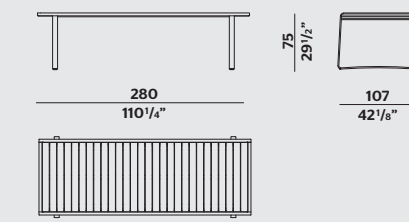

LAVA STONE TOP TABLE
TAVOLO PIANO PIETRA LAVICA

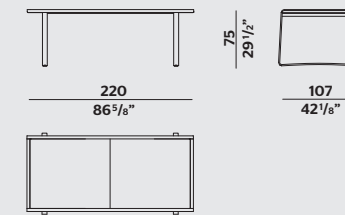

LAVA STONE TOP TABLE
TAVOLO PIANO PIETRA LAVICA

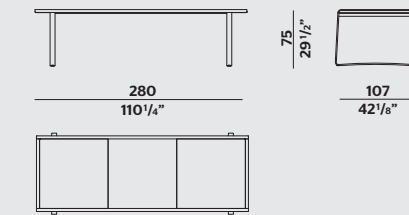

GREEN POINT VINCENT VAN DUYSSEN

BENCH
PANCA

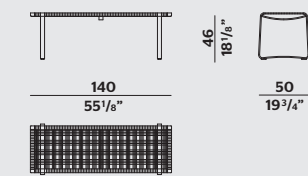

BENCH
PANCA

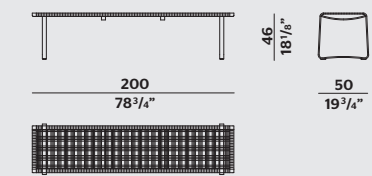

CHAIR
SEDIA

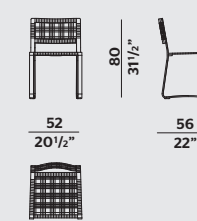

CHAIR WITH ARMRESTS
SEDIA CON BRACCIOLI

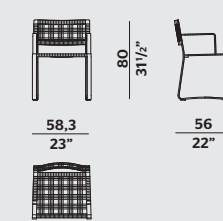

STOOL
SGABELLO

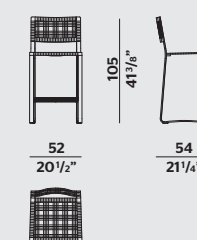

Timeout Collection

GUELL VINCENT VAN DUYSSEN

SUNBED TEAK VERSION
LETTINO VERSIONE TAEK

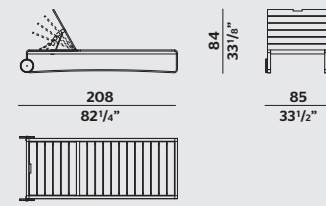

SUNBED WOVEN ROPE VERSION
LETTINO VERSIONE INTRECCIO

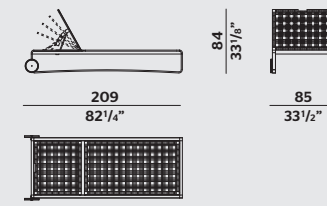

REGENT VINCENT VAN DUYSSEN

RECTANGULAR COFFEE TABLE
TAVOLINO RETTANGOLARE

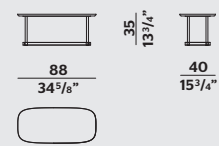

RECTANGULAR COFFEE TABLE
TAVOLINO RETTANGOLARE

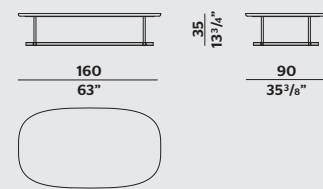

SQUARE COFFEE TABLE
TAVOLINO QUADRATO

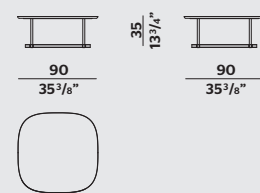

SQUARE COFFEE TABLE
TAVOLINO QUADRATO

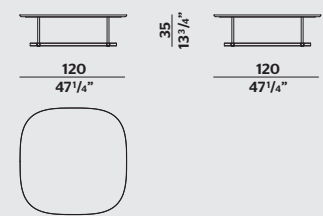

ROUND COFFEE TABLE
TAVOLINO TONDO

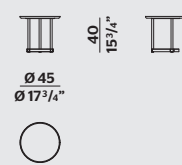

ROUND COFFEE TABLE
TAVOLINO TONDO

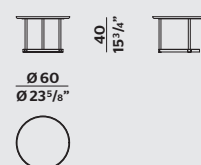

ROUND COFFEE TABLE
TAVOLINO TONDO

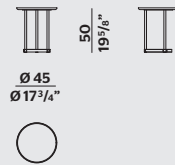

ROUND COFFEE TABLE
TAVOLINO TONDO

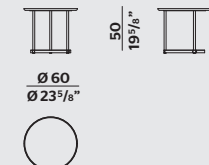

HYDE VINCENT VAN DUYSSEN

POUF

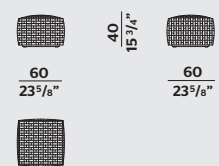

POUF

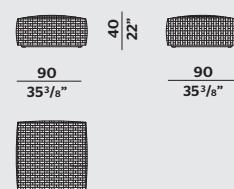

Timeout Collection

BOULOGNE VINCENT VAN DUYSSEN

BASKET
CESTA

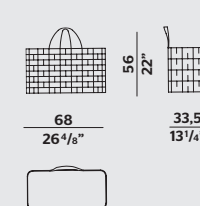

BASKET
CESTA

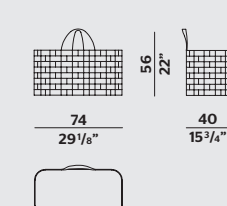

BASKET
CESTA

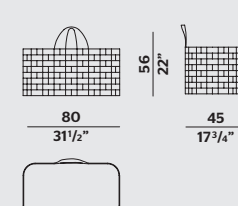

UENO VINCENT VAN DUYSSEN

SCREEN
PARAVENTO

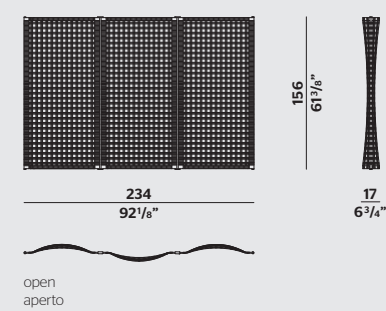

Iconic pieces

ARC FOSTER + PARTNERS

TABLE
TAVOLO

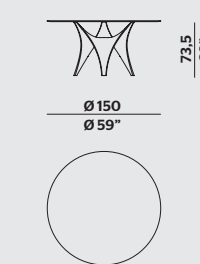

PANNA COTTA RON GILAD

COFFEE TABLE
TAVOLINO

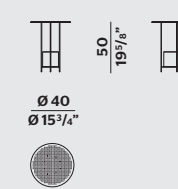

COFFEE TABLE
TAVOLINO

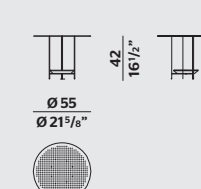

AD—
VINCENT VAN DUYSSEN

PHOTO—
MAX ZAMBELLI
FREDERIK VERCRUYSSSE

COVER—
KARL BLOSSFELDT,
CHRYSANTHEMUM
PARTHENIUM, BEFORE 1928

THANKS TO—

KARL BLOSSFELDT ARCHIV / STIFTUNG ANN UND JÜRGEN WILDE,
BAYERISCHE STAATSGEMÄLDESAMMLUNGEN, MÜNCHEN

AIKIKO HIRAI
JOJO CORVÁIA
MARC RICOURT
MARCO BELLINI
SABINE PAGLIARULO

REPRESENTED BY KALPA ART LIVING GALLERY

ASTEP
ATELIER VIERKANT
CORRADO CORRADI
DAVIDE GROPPI
EDITIONS MILANO
FEDERICA BUBANI
FLOS
IMPERFETTO LAB
LUCEPLAN
LUMINA
MARTINA GERONI
NEMO
ONCE MILANO
VILLA TALAMO



moltenigroup.com
moltenimuseum.com
#MolteniGroup
#MolteniMuseum



Molteni&C Selected pieces
now available also at shop.molteni.it



ONLINE STORE 
for US market

Molteni & C | UniFor | CITTERIO