

Culture and Craft

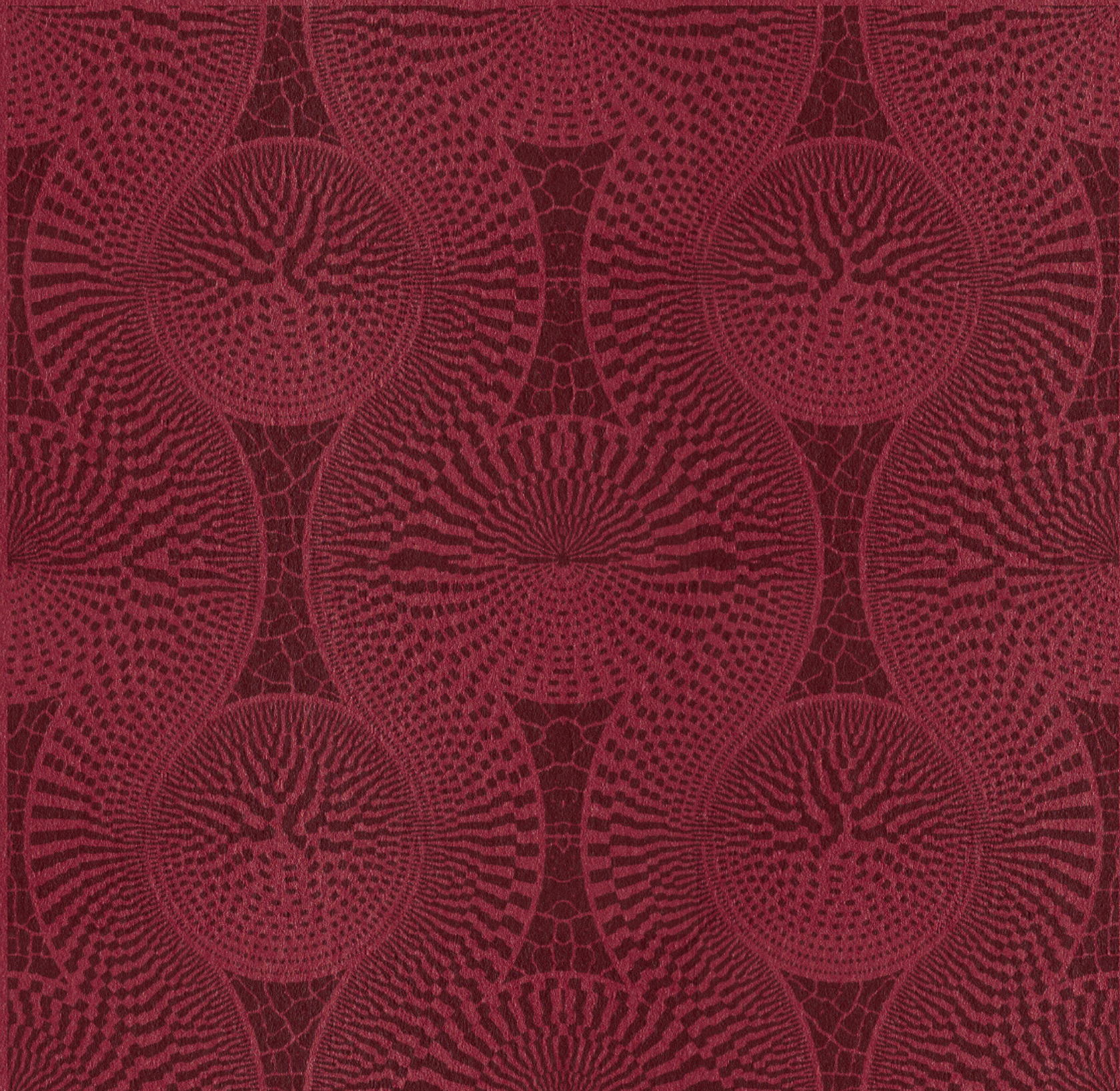

OZWALD BOATENG X



OZWALD BOATENG

X



Culture and Craft

"My name is Ozwald Boateng.
I'm a designer, but I'm known for my tailoring.
With Poltrona Frau I saw it immediately you
know when I explored the opportunity of
the materials, the leather, and then when I
discovered the craftsmanship, it was very clear
to me that this is a collaboration I could do.

Poltrona Frau has got a long history.
So I like the idea of taking something which
has been there and looking at modern ways to
revitalize it, but with full respect of its history.





The point of contact between myself and Poltrona Frau is the respect for tradition, a real appreciation of quality and craftsmanship, and a desire to look forward.

Italian craftsmanship.

Clearly, there's an English component.

And then, of course, my cultural background is also blended. So this is an interesting fusion of all these different cultures.

I gravitated to the Chester family, because it relates to a piece of furniture that speaks tradition. And tradition is something I'm always drawn to in my work, and I'm drawn to it because I always look at how I can make tradition evolve and become more modern."

— Ozwald Boateng









The basis of the Ozwald Boateng x Poltrona Frau partnership is founded in a shared passion for precision, artistry and craft. Much like the fastidiously hand-measured and hand-cut garments Boateng produces for his legions of dedicated clients, Poltrona Frau's approach to artisanship is similarly bespoke but has industry leading capabilities in research and development that push the boundaries of innovation in design, leather craftsmanship.

In conceiving the collection, Boateng and Poltrona Frau combined their distinct fields of artisanship and respective cultural heritages, ultimately devising a collection that unites the two worlds: on one hand, Poltrona Frau's prestigious Made in Italy craftsmanship, and on the other, Ozwald Boateng's distinctive expression and British tailoring expertise coupled with the joyousness of African aesthetics.

With a creative approach rooted in London's Savile Row tradition, which houses some of the world's most prestigious tailoring ateliers, the British designer of Ghanaian origins combines classic silhouettes with bold patterns and highly contemporary details, promoting a style that reflects his rich cultural heritage through a cosmopolitan perspective.

This original approach is applied to the new collection, which sees as protagonists the reinterpretations of the Chester sofa & armchair and Vanity Fair armchair designs, as well as new accessories within Poltrona Frau's Beautilities category. The 'Tribal' pattern, signature print of Boateng, is featured across all products: it pays homage to his Ghanaian's origins, with each colour, pattern and design carefully conceived to narrate a strong spiritual story and to act as a cloak armour for the objects' owner. The new collection applies the best of bespoke couture to timeless design, paving the way for significant manufacturing innovations, such as the novel use of embossing in leather craftsmanship, experimented here for the first time.

Inspired by the rigorous codes that define traditional English tailoring, the centerpiece of the collection is a contemporary reimagining of Poltrona Frau's iconic Chester sofa across all three Chester offerings: Chester, Chester One and Chester Line. Designed in 1912, the rolled, pleated armrests and quilted finish were inspired by the classic Edwardian Chesterfield sofas Poltrona Frau's founder Renzo Frau discovered on his voyages to England. In Boateng's hands, however, an entirely new dimension

is added. Known for designing with vibrantly patterned textiles drawn from his Ghanaian background, Boateng and Poltrona Frau spent over six months developing a hand-embossed leather whose motif was inspired by traditional Kente cloths, brightly woven fabrics typically worn on formal occasions. Each Chester sofa is then hand-crafted in Poltrona Frau's atelier in Tolentino with the same care and attention as one of Boateng's handmade suits.



AFRICAN TRIBAL & KENTE PATTERNS

African arts deliver many messages about the spiritual world, culture, religion, power, status, and social messages. The Tribal print is a reinterpretation of traditional African cloth, highlighting the continent's continued progress towards autonomy and preserving Africa's distinct heritage of craftsmanship at its heart. Ozward

Boateng's tribal pattern answers the global demand and love for its ancestral prints. The Kente print has origins from the Ashanti/Akan people of Ghana and is mostly very brightly coloured or dark, depending on the occasion it is used for. Originally, the Ashanti only used it for highly sacred ceremonies, but due to modernity, the Kente cloth is

now used globally for any occasion. The general design of Kente is made with abstract ideas and, at times, based on the nature of the occasion it is worn for. The designs, if not based on ideas, are then based on colors. In Ghana, colors are a very important aspect of the culture.





Chester 3-seater sofa, Pelle Frau® Nubuck Tribal Green color
Vanity Fair armchair, Velvet Fabric Tribal Green color
Decorative cushions, Pelle Frau® Nubuck Tribal Green color
Wallpaper, Kente design in Green color
Carpet, Anthracite color

THE CHESTER LINE

The Chester line is "dressed" by Ozwald Boateng in three versions: classic Chester, Chester Line, and Chester One, featuring a new upholstery characterized by the Tribal pattern --a signature print of the designer. The pattern is applied using the hot embossing technique on Pelle Frau® Nubuck leather. This particular technique, executed manually, represents a groundbreaking innovation in leather craftsmanship. The process, developed over approximately six months by Poltrona Frau's team of designers and R&D specialists,

involves placing each individual leather piece on a press base with a smooth metal surface on the bottom and a bakelite plate on top. The resulting effect is highly textured and three-dimensional, further enhanced by the choice of intense and warm color tones such as red, yellow, purple, green, black and blue --specifically created by Boateng for this upholstery. These hues evoke the African textile tradition, a source of inspiration for the fashion designer, but are reinterpreted in an extremely contemporary manner to give them a distinctive character.









➤ Chester Line, Pelle Frau® Nubuck Tribal Purple color
Vanity Fair armchair, Velvet Fabric Tribal Purple color
Decorative cushions, Pelle Frau® Nubuck Tribal Purple color
Carpet, Green color



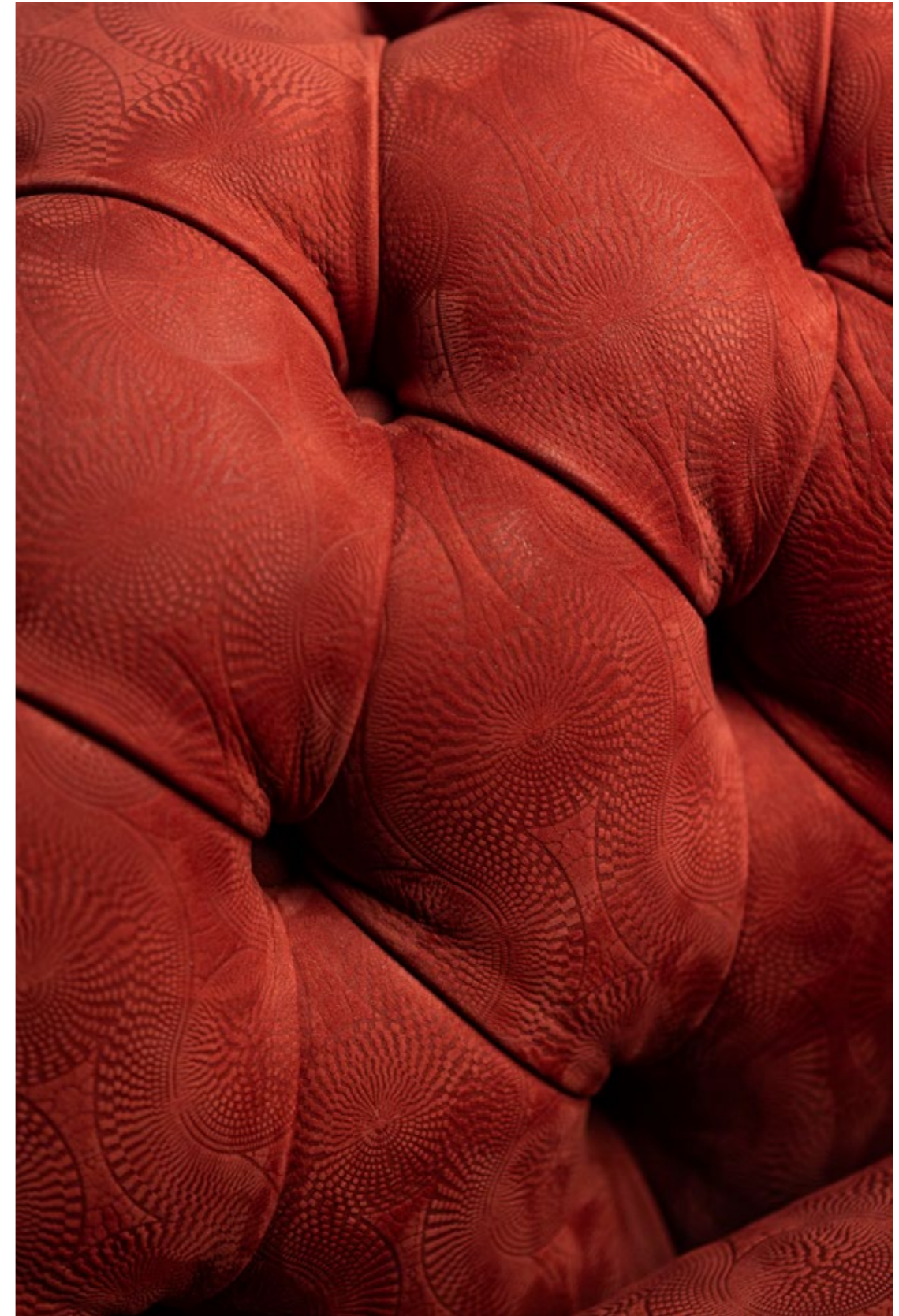

↖ ↑ Chester 3-seater sofa, Pelle Frau® Nubuck Tribal Red color



Chester One sofa, Pelle Frau® Nubuck Tribal Red color
Chester Line ottoman, Pelle Frau® Nubuck Tribal Red color
Vanity Fair armchair, Velvet Fabric Tribal Yellow color

Decorative cushions, Pelle Frau® Nubuck Tribal Red color
Wallpaper, Kenté design
Carpet, Red color



THE VANITY FAIR

The Vanity Fair and Vanity Fair XC armchairs are presented with a new Velvet-Fabric Tribal upholstery that creates a matte effect, also enriched with the Tribal pattern, an authentic signature of the Boateng fashion house. Through digital printing, the pattern comes to life on the fabric: its rounded and repetitive geometries, inspired by ancestral African motifs, emerge

with strength and grace, enhancing the graphic design and providing a sense of depth, accentuated by the contrasts between full and empty spaces and the shades of light and dark. Similar to the reinterpretation of the Chester, the color palette specifically created for the Tribal pattern ranges from warm tones of reds, and yellows to vibrant greens, and purples.





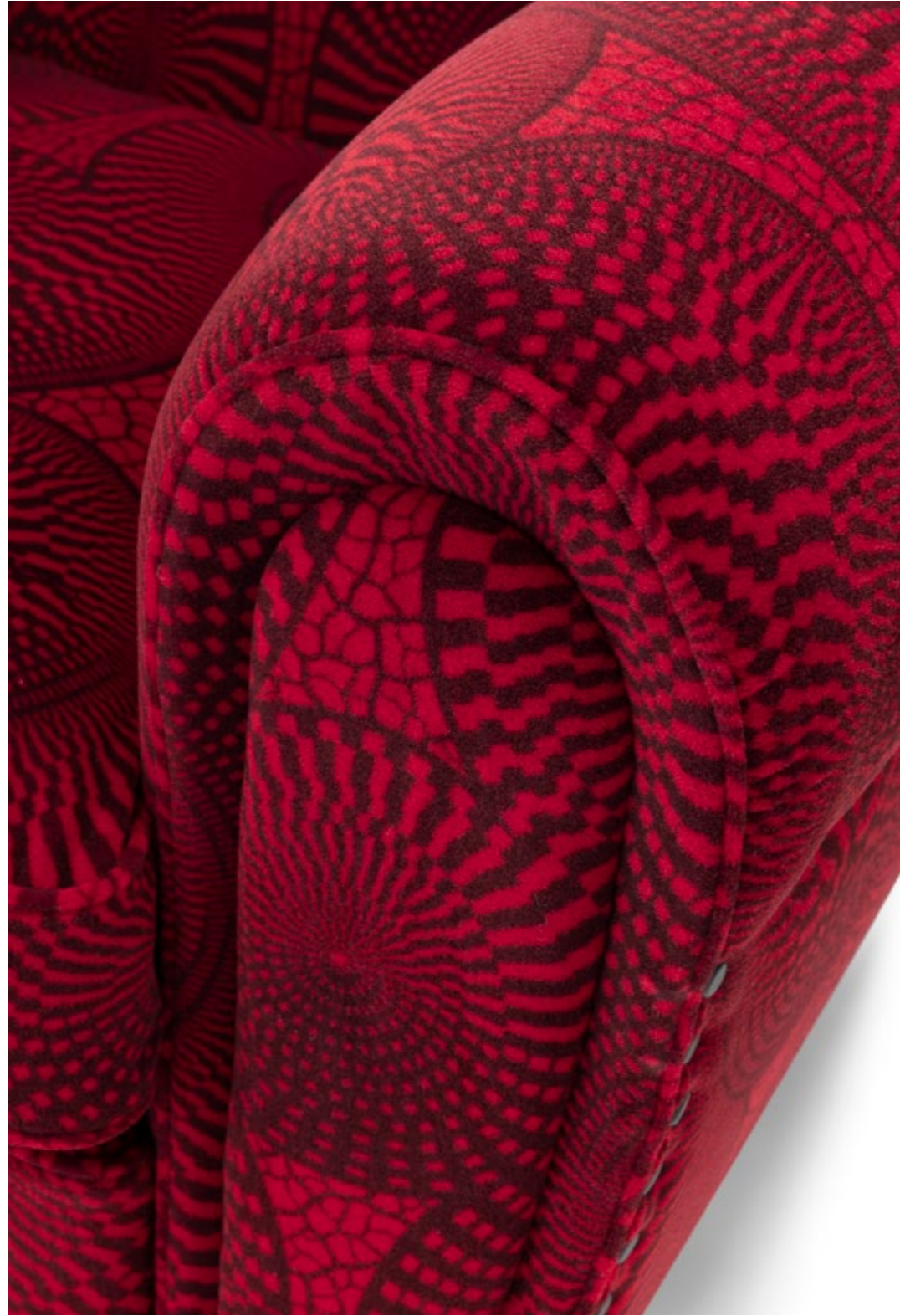







THE BEAUTILITIES COLLECTION

The Ozward Boateng x Poltrona Frau collaboration also developed into a Beautilities collection consisting of objects characterized by the highest craftsmanship, stunning aesthetics, and impeccable functionality. Beautilities is a new collection of well-being accessories and complements for everyday use. The new offering expresses a fascinating duality, the perfect combination of distinctive aesthetics and impeccable functionality. Each accessory is synonymous with a craftsmanship culture rooted in tradition but with a forward-looking

approach. The collection includes a soft monochromatic wool rug available in three sizes; a set of cushions with upholstery featuring the Tribal pattern, designed to complement the upholstered furniture; a wallpaper, brand-new addition to Poltrona Frau's catalog, enriched with the Tribal and Kente motifs and available in a range of colors; a scented candle with a glass holder, offered in three intense and bold fragrances, inspired by scents from the African continent; and lastly, the Mancala board game. This game, widely spread across the African continent, comprises a board

and pieces (traditionally seeds) which have been reinvented here, both in materials and form: the board is made of precious dark wood, while the pieces are finely crafted from Murano glass by skilled artisans, creating a visual effect resembling tiny droplets of water crossed by rays of light.







"*Il mio nome è Oswald Boateng. Sono un designer, ma sono noto per la mia sartoria. Quando ho esplorato l'opportunità di lavorare con i materiali e la pelle di Poltrona Frau, ho capito immediatamente che era una collaborazione che potevo intraprendere. Poltrona Frau ha una lunga storia, e mi piace l'idea di prendere qualcosa che viene dal passato e cercare modi moderni per rivitalizzarlo, mantenendo al contempo il massimo rispetto per la sua storia.*

Il punto di contatto tra me e Poltrona Frau è il rispetto per la tradizione, l'apprezzamento per la qualità e per l'artigianalità, e il desiderio di guardare avanti. Artigianalità italiana. Chiaramente, c'è una componente inglese coinvolta. E poi, naturalmente, c'è mescolato anche il mio background culturale. E' un'interessante fusione di tutte queste diverse culture. Mi sono orientato verso la famiglia Chester, perché si tratta di un pezzo di arredamento che rappresenta la tradizione. E la tradizione è qualcosa a cui sono sempre attratto nel mio lavoro, e lo sono perché cerco costantemente di far evolvere la tradizione e renderla più moderna."

- Oswald Boateng

La partnership Oswald Boateng x Poltrona Frau è fondata su una passione condivisa per la precisione sartoriale, l'arte e l'artigianato. Così come i capi d'abbigliamento che Boateng produce per la sua fedele clientela sono accuratamente misurati e tagliati a mano, anche l'approccio di Poltrona Frau all'artigianato è altrettanto personalizzato, e vanta inoltre una vasta expertise nel settore di Ricerca & Sviluppo, che la porta a spingere costantemente i confini dell'innovazione nel design e nella lavorazione della pelle.

Boateng e Poltrona Frau hanno unito i loro rispettivi settori artigianali e patrimoni culturali, sviluppando una collezione che unisce i due mondi: da un lato, il prestigioso artigianato Made in Italy di Poltrona Frau, dall'altro, l'espressione distintiva di Oswald Boateng e l'esperienza sartoriale britannica unita alla ricchezza dell'estetica africana.

Con un approccio creativo radicato nella tradizione di Savile Row di Londra, che ospita alcuni dei più prestigiosi atelier di sartoria del mondo, il designer britannico di origine ghanese combina silhouette classiche con audaci motivi e dettagli estremamente contemporanei, promuovendo uno stile che riflette la sua ricca eredità culturale attraverso una prospettiva cosmopolita.

Questo approccio originale è applicato alla collezione che vede come protago-

niste le reinterpretazioni dei design del Chester sofa e poltrona e della poltrona Vanity Fair, oltre a nuovi accessori nella categoria Beautilities di Poltrona Frau, una sezione recentemente inaugurata con complementi quotidiani che mettono al centro il well-being. Il motivo "Tribal", signature print di Boateng, è presente in tutti i prodotti: un omaggio alle sue origini ghanesi e a colore, motivo è accuratamente concepito per raccontare una profonda storia spirituale e per diventare una sorta di mantello-armatura del prodotto.

La nuova collezione unisce il meglio della bespoke couture al design senza tempo, aprendo la strada a significative innovazioni produttive, come l'uso inedito della tecnica della goffratura nella lavorazione della pelle (embossing), sperimentata qui per la prima volta.

Ispirato ai codici rigorosi che definiscono la sartoria tradizionale inglese, il fulcro della collezione è una rivisitazione contemporanea dell'iconico divano Chester di Poltrona Frau in tutte e tre le proposte: Chester, Chester One e Chester Line. Progettato nel 1912, i braccioli a pieghe e la finitura trapuntata si ispirano ai classici divani Chesterfield edoardiani che il fondatore di Poltrona Frau, Renzo Frau, aveva scoperto durante i suoi viaggi in Inghilterra. Nelle mani di Boateng, tuttavia, viene aggiunta una dimensione completamente nuova. Conosciuto per i suoi design realizzati con tessuti dalle fantasie vivaci, ispirati al suo background ghanese, Boateng ha trascorso più di sei mesi insieme a Poltrona Frau per sviluppare una pelle goffrata a mano il cui motivo si rifà alle tradizionali stoffe Kente, tessuti dalla trama vivace tipicamente indossati nelle occasioni formali. Ogni divano Chester viene poi realizzato a mano nell'atelier di Poltrona Frau a Tolentino con la stessa cura e attenzione di uno degli abiti fatti a mano da Boateng.

I MOTIVI AFRICANI TRIBAL E KENTE
Il design generico del Kente è realizzato a partire da idee astratte e, a volte, basato sulla natura dell'occasione per cui viene indossato. I disegni, quando non nascono dalle idee, si basano sui colori. In Ghana, i colori sono infatti un aspetto molto importante della cultura: le tonalità che una persona indossa per un tipo di cerimonia lasciano presumere la qualità dell'educazione ricevuta da quella persona.
Le arti africane trasmettono molti messaggi riguardo al mondo spirituale, alla cultura, alla religione, al potere, allo status e ai messaggi sociali. La stampa tribale è una reinterpretazione del tradizionale tessuto africano, mettendo in evidenza il progresso continuo del continente verso l'autonomia e la preservazione dell'artigianato distintivo dell'Africa nel suo cuore. Il motivo

tribale di Oswald Boateng risponde alla domanda globale e all'amore per le sue stampe ancestrali.
La stampa Kente ha origini nel popolo Ashanti/Akan del Ghana ed è principalmente molto colorata o scura, a seconda dell'occasione per cui viene utilizzata. Originariamente, gli Ashanti la utilizzavano solo per cerimonie altamente sacre, ma a causa della modernità, il tessuto Kente è ora utilizzato globalmente per qualsiasi occasione.

LA LINEA CHESTER

La linea Chester è "vestita" da Oswald Boateng in tre versioni: Chester classico, Chester Line e Chester One, con il nuovo rivestimento caratterizzato dal motivo Tribal, firmato dal designer. Il motivo è applicato con la tecnica della goffratura a caldo sulla Pelle Frau® Nubuck. Questa particolare tecnica, eseguita manualmente, rappresenta un'innovazione rivoluzionaria nella lavorazione della pelle. Il processo, sviluppato in circa sei mesi dal team di designer e specialisti di Ricerca & Sviluppo di Poltrona Frau, prevede che ogni singolo pezzo di pelle venga posizionato sulla base di una pressa con una superficie metallica liscia sul fondo e una piastra in bachelite sulla parte superiore. L'effetto risultante è altamente texturizzato e tridimensionale, ulteriormente esaltato dalla scelta di cromie intense e ricche come il nero, il rosso, il giallo, il viola, il verde e il blu, appositamente create da Boateng per questo rivestimento. Queste tonalità evocano la tradizione tessile africana, fonte di ispirazione per il fashion designer, ma sono reinterpretate in modo estremamente contemporaneo per conferire loro un carattere distintivo.

LA POLTRONA VANITY FAIR

Le poltrone Vanity Fair e Vanity Fair XC sono presentate con un nuovo rivestimento in tessuto di velluto che crea un effetto opaco, arricchito dal motivo Tribal, segno distintivo della casa di moda Boateng. Grazie alla stampa digitale, il motivo prende vita sul tessuto: le sue geometrie arrotondate e ripetitive, ispirate a motivi africani ancestrali, emergono con forza e grazia, esaltando il disegno grafico e dando un senso di profondità, accentuato dai contrasti tra pieni e vuoti e dalle sfumature di chiaro e scuro. Analogamente alla reinterpretazione del Chester, la palette di colori creata appositamente per il motivo Tribal spazia dai toni caldi dei rossi e dei gialli ai vibranti verdi e viola.

LA COLLEZIONE BEAUTILITIES
La partnership Oswald Boateng x Poltrona Frau ha dato vita anche a una collezione Beautilities, che consiste in oggetti caratterizzati dalla più alta artigianalità, da un'estetica straordinaria e da una funzionalità impeccabile. Beautilities è una nuova collezione di accessori per

il benessere e di complementi per l'uso quotidiano. La nuova offerta esprime un'affascinante dualità, la perfetta combinazione tra un'estetica distintiva e una funzionalità impeccabile. Ogni accessorio è sinonimo della cultura artigianale che affonda le sue radici nella tradizione, ma con un approccio orientato al futuro.
La collezione comprende un morbido tappeto monocromatico in lana disponibile in tre dimensioni; un set di cuscini rivestiti con il motivo Tribal, appositamente studiati per abbinarsi agli arredi imbottiti; una carta da parati, novità assoluta del catalogo Poltrona Frau, arricchita con i motivi Tribal e Kente e disponibile in una vasta gamma di colori; una candela profumata con portacandela in vetro, proposta in tre fragranze intense e decise, ispirate ai profumi del continente africano; infine, il gioco da tavolo Mancala. Questo gioco, molto diffuso nel continente africano, è composto da un tavoliere e da una serie di pedine (tradizionalmente semi) che qui sono stati reinventati, sia nei materiali che nella forma: il tavoliere è realizzato in prezioso legno scuro, mentre le pedine in vetro di Murano sono finemente lavorate da esperti artigiani, che hanno ottenuto un effetto visivo simile a piccole gocce d'acqua attraversate da raggi di luce.

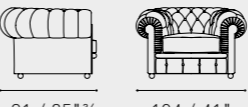
Chester			
			
5107111			
	$67 / 26^{*}\frac{1}{2}$	$65 / 25^{*}\frac{1}{2}$	$43 / 17^{*}$
		$91 / 35^{*}\frac{3}{4}$	$104 / 41^{*}$

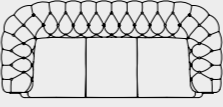
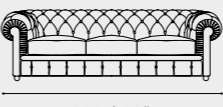
			
5107311			
	$67 / 26^{*}\frac{1}{2}$	$65 / 25^{*}\frac{1}{2}$	$43 / 17^{*}$
		$91 / 35^{*}\frac{3}{4}$	$208 / 82^{*}$

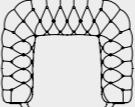
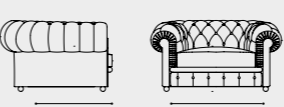

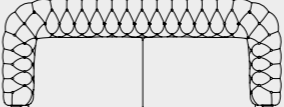
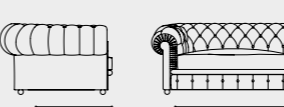
			
5107112			
	$67 / 26^{*}\frac{1}{2}$	$43 / 17^{*}$	
		$65 / 25^{*}\frac{1}{2}$	$56 / 22^{*}$
		$106 / 41^{*}\frac{3}{4}$	$122 / 48^{*}$

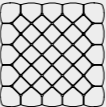
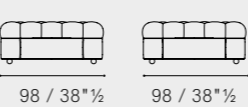
			
5107411			
	$67 / 26^{*}\frac{1}{2}$	$43 / 17^{*}$	
		$69 / 27^{*}\frac{1}{4}$	$197 / 77^{*}\frac{1}{2}$
		$106 / 41^{*}\frac{3}{4}$	$263 / 103^{*}\frac{1}{2}$

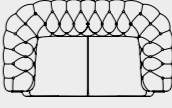
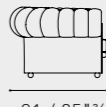
			
5107512			
	$40 / 15^{*}\frac{3}{4}$		
		$98 / 38^{*}\frac{1}{2}$	$98 / 38^{*}\frac{1}{2}$

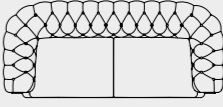
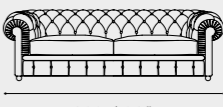
			
5107211			
	$67 / 26^{*}\frac{1}{2}$	$65 / 25^{*}\frac{1}{2}$	$43 / 17^{*}$
		$91 / 35^{*}\frac{3}{4}$	$160 / 63^{*}$

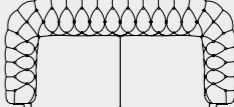
			
5107311			
	$67 / 26^{*}\frac{1}{2}$	$65 / 25^{*}\frac{1}{2}$	$43 / 17^{*}$
		$91 / 35^{*}\frac{3}{4}$	$208 / 82^{*}$

			
5107312			
	$67 / 26^{*}\frac{1}{2}$	$43 / 17^{*}$	
		$69 / 27^{*}\frac{1}{4}$	$152 / 59^{*}\frac{3}{4}$
		$106 / 41^{*}\frac{3}{4}$	$218 / 85^{*}\frac{3}{4}$

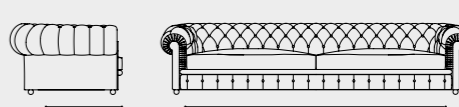
			
5107551			
	$67 / 26^{*}\frac{1}{2}$	$43 / 17^{*}$	
		$69 / 27^{*}\frac{1}{4}$	$227 / 89^{*}\frac{1}{4}$
		$106 / 41^{*}\frac{3}{4}$	$293 / 115^{*}\frac{1}{4}$

Chester Line

5617122

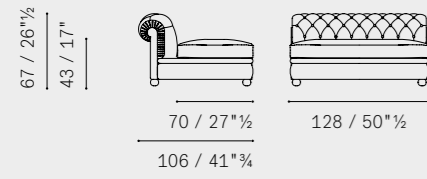
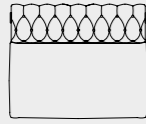

5617146

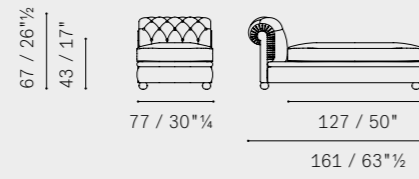

5617221

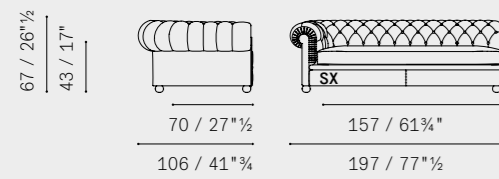
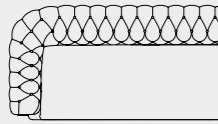

5617511

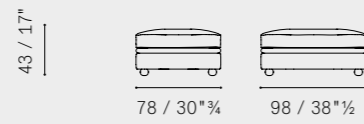

Decorative Cushions

5305561



Mancala board game

5679102

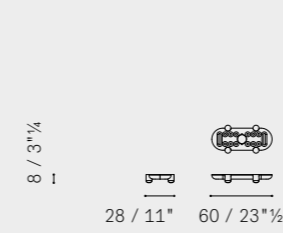

Vanity Fair

5163111

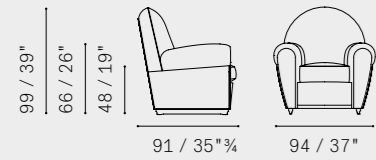

5163511

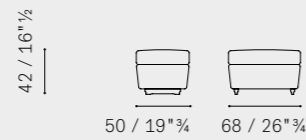

Carpet

5679101

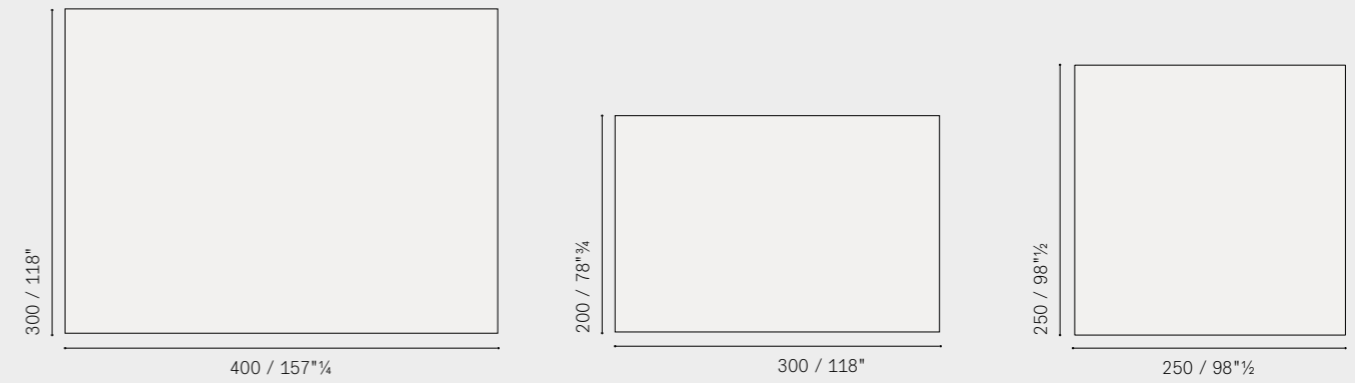

Vanity Fair XC

5163115

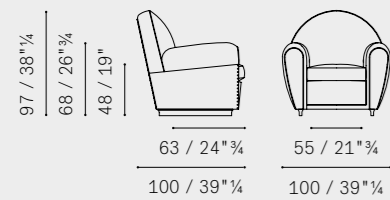

5163515

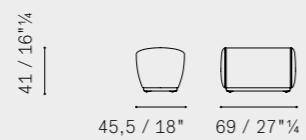

5163515

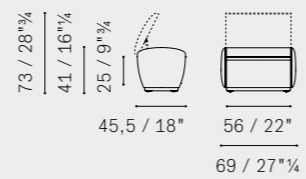

CONTACTS

Poltrona Frau S.p.A

a socio unico

Sede legale in Meda (MB)

Via Luigi Busnelli 1

20821 Italy

Sede operativa in Tolentino (MC)

Via Sandro Pertini 22

62029 Italy

Tel. +39 0733 909.1

Fax +39 0733 971600

www.poltronafrau.com

CREDITS

Project developed by the

Marketing & Communications

dept. of Poltrona Frau spa

Lifestyle CGI Photography

ROSSETTI Interiors

Still-life Photography

Alessio D'Aniello

Post production / Color selection

Pan Group Milano

© POLTRONA FRAU 2023

Poltrona Frau reserves the right to modify the products and the components in this price list, without any prior notice. Company with certified Quality Management System in accordance with ISO 9001, certified Environmental Management System in accordance with ISO 14001, certified Occupational Health and Safety Management System in accordance with BS OHSAS 18001, certified Chain of Custody System in accordance with Forest Stewardship Council® FSC-STD-40-004 (FSC-C153281).

Company subject to management and co-ordination of Haworth Italy Holding S.r.l.

