



FAS Pendezza *“Let’s play with our **DESIGN** collection”*



## Storia di un'eccellenza Bergamasca

**FAS Pendezza Srl** nasce nel 1964 a Villa d'Ogna, alta Val Seriana per creare strumenti di gioco e divertimento per adulti e bambini, realizzati con materie prime di altissima qualità e lavorati dai migliori artigiani della tradizione bergamasca. Sono nati così: il calciobalilla, il tavolo da ping pong e il biliardo di FAS, icone di eleganza e qualità. Apprezzati quali eccellenze artigianali italiane, i prodotti marchiati FAS Pendezza hanno guadagnato e consolidato negli anni riconoscimenti a livello nazionale e internazionale.

## The story of Bergamo excellence

**FAS Pendezza Srl** was founded in 1964 at Villa d'Ogna, in the upper Val Seriana for creating games and entertainment tools for adults and children, made with high quality raw materials and processed by best artisans of the Bergamo tradition. This is how the FAS football table, table tennis and billiard table were born: icons of elegance and quality. Appreciated as Italian artisan excellences, the FAS Pendezza products have gained and consolidated over the years national and international awards.

## "MADE IN ITALY" è il nostro motto

FAS Pendezza crede nel **Made in Italy**, e proprio per questo l'intero processo produttivo si svolge in Italia. Una stringente selezione dei fornitori, a loro volta aziende italiane altamente qualificate, permette un controllo capillare della filiera garantendo qualità di prodotto.

## "MADE IN ITALY" is our motto

FAS Pendezza believes in **Made in Italy**, and for this reason the entire production process takes place here. A stringent selection of suppliers, highly qualified Italian companies, allows a strict control of the supply chain, guaranteeing product quality.

## I nostri valori

Soddisfazione del cliente, coinvolgimento e benessere dei dipendenti, continuo miglioramento di materiali e di processi: questi sono alcuni dei nostri valori cardine. Tutti i prodotti FAS Pendezza sono realizzati secondo gli standard di conformità **UNI EN ISO 9004**.

## Our values

Customer satisfaction, employees involvement and well-being, continuous improvement of materials and processes: these are some of our core values. All FAS Pendezza products are manufactured according to **UNI EN ISO 9004** compliance standards.

## Branding e personalizzazione

Un'attenzione speciale nella politica aziendale di FAS è riservata al settore del **branding** e della **personalizzazione** dei suoi prodotti. Questo prezioso servizio ha permesso all'azienda di lavorare con i più **conosciuti marchi a livello mondiale**, aiutandoli a promuovere il loro marchio con una modalità nuova e smart.

## Branding and customization

FAS in its policy pays a special focus to **branding** and **customization** products for promotion and incentive purposes. This valuable service has allowed the company the chance to **work with many of the world largest and best-known brands**, helping them to promote product loyalty and brand recognition.

## Ricerca continua per prodotti dal design inaspettato

FAS investe continuamente nelle nuove tecnologie e nel design, grazie alla collaborazione con lo studio Basaglia + Rota Nodari, così da poter offrire al consumatore finale un prodotto unico e molto performante. È attraverso questa semplice ricetta che oggi i giochi di FAS Pendezza sono **popolari in tutto il mondo**.

## Continuous search of unexpected design products

FAS continuously invests in new technologies and design, thanks to the collaboration with studio Basaglia + Rota Nodari, so to be able to offer to the final consumer a unique and highly performing product. It's thanks to this simple recipe that FAS Pendezza games are today **popular all over the world**.



**CALCIOBALILLA /  
TABLE FOOTBALL**



**Cross** - Indoor [ pag.5 ]



**Cross Outdoor** - Outdoor / Indoor [ pag.11 ]



**Ghost** - Indoor [ pag.17 ]



**Apollo** - Outdoor / Indoor [ pag.27 ]



**Ciclope** - Outdoor / Indoor [ pag.35 ]



**Ciclope Capri** - Outdoor / Indoor [ pag.43 ]



**Fido** - Indoor [ pag.51 ]



**Flamingo** - Indoor [ pag.61 ]



**Tour '65** - Indoor [ pag.69 ]

**CARAMBOLE /  
POOL TABLES**



**Étoile** - Indoor [ pag.77 ]



**Cubista** - Indoor [ pag.85 ]

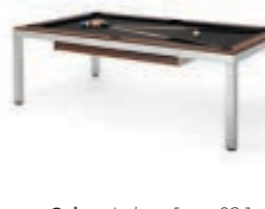

**Cube** - Indoor [ pag.93 ]

**PING PONG /  
TABLE TENNIS**



**Dada** - Indoor [ pag.103 ]



**Dada Outdoor** - Outdoor / Indoor [ pag.113 ]



**Grasshopper** - Indoor [ pag.121 ]



**Grasshopper Outdoor** - Outdoor / Indoor [ pag.131 ]



**Spider** - Indoor [ pag.139 ]

\* FAS Pendezza si riserva il diritto di apportare eventuali modifiche di parti o dettagli ritenuti necessari.  
\* FAS Pendezza has the right to change at any time the parts or details it deems necessary.





# CROSS

indoor

design Basaglia + Rota Nodari



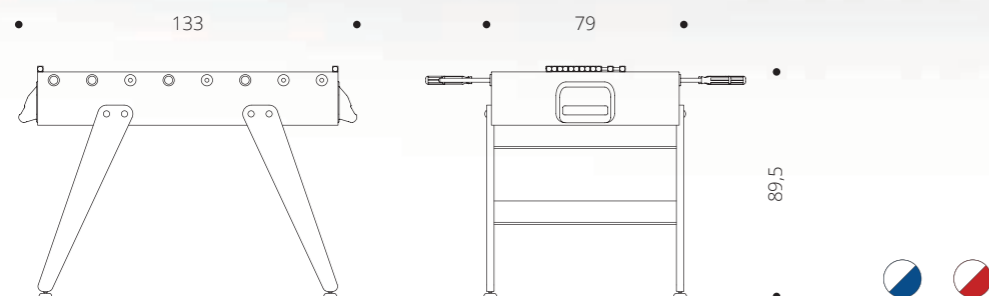
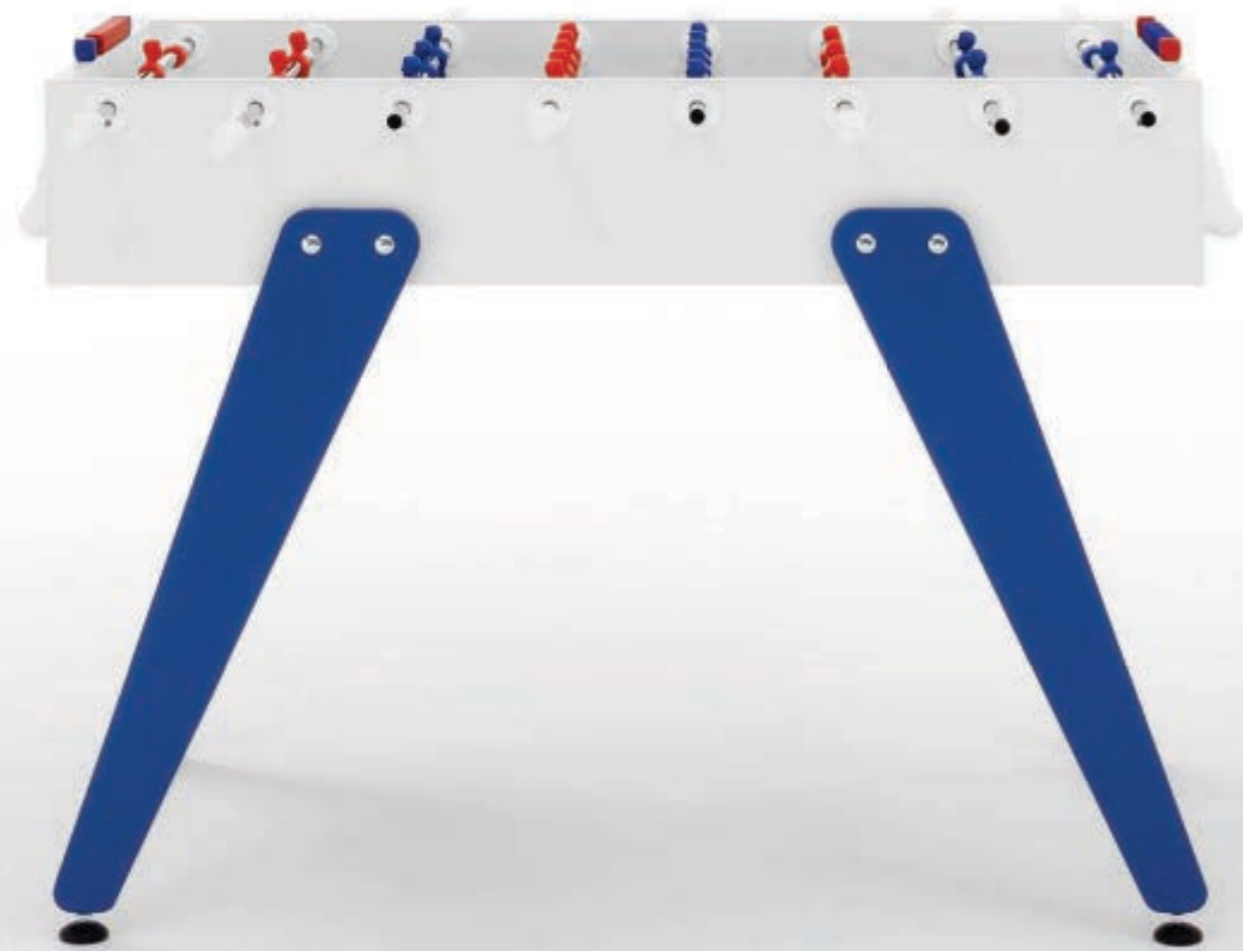

Cross è un calciobalilla contemporaneo apprezzato per le sue linee essenziali, che ricordano un design classico e allo stesso tempo intramontabile. Una linea ricercata e pulita si forma dalla connessione tra gambe e top per mezzo di borchie metalliche. Il colore blu e rosso delle gambe si abbina ai colori dei giocatori: Cross è ricerca ed essenzialità, Cross rispecchia ciò che siamo.

*Cross is a contemporary football table appreciated for its essentiality, reminiscent of a classic but timeless design. A sophisticated but yet clean line is formed by the connection of legs and playing field through metal studs. The available colors of the frame match the players on the field: this is essentiality, this is what we are.*



Cross è un calciobalilla contemporaneo apprezzato per le sue linee essenziali, che ricordano un design classico intramontabile

*Cross is a contemporary football table appreciated for its essentiality, reminiscent of a classic but timeless design*





# **CROSS *Outdoor*** outdoor

design Basaglia + Rota Nodari



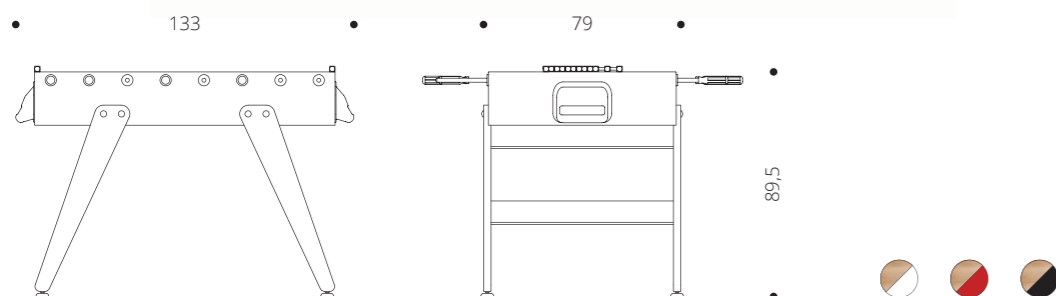

Cross Outdoor è un calciobalilla disponibile in tre diverse finiture colore. Le gambe sono in multistrato di betulla, un gusto squisito, il tocco del legno naturale e il piacere di giocare una partita circondati dagli elementi naturali; non è forse questo un ottimo modo di creare ricordi indelebili? Progettato per resistere ai segni del tempo, Cross Outdoor è il calciobalilla che armonizza con la natura, lasciati accompagnare nei tuoi momenti migliori.

*Birch plywood legs, three possibilities of color, Cross Outdoor is the football table that harmonizes with nature. An exquisite taste, the touch of natural wood and the pleasure of playing surrounded by natural elements; isn't it a great way to create lasting memories? Cross outdoor is designed for long-term durability. Let us accompany you in the most beautiful moments.*





*Cross Outdoor* è il  
calciobalilla che armonizza  
con la natura

*Cross Outdoor* is the football  
table that harmonizes with  
nature







# GHOST

indoor

design Basaglia + Rota Nodari



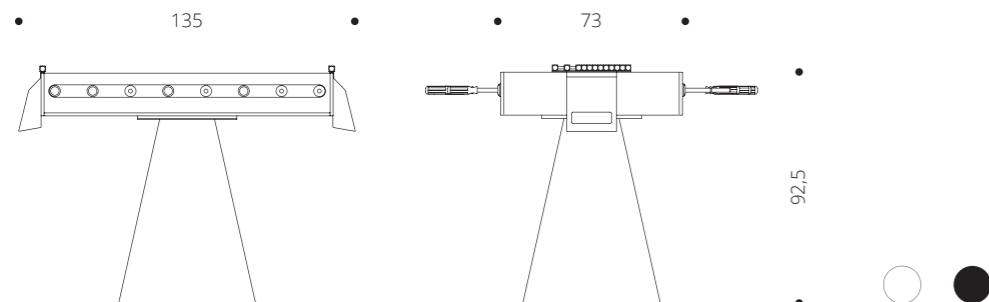

Ghost ha un portamento elegante e affascinante, è una presenza preziosa dalla personalità discreta. Non è un oggetto da "guardare e non toccare" ma è un calciobalilla professionale perfetto sia per le sfide tra campioni che per gli appassionati di questo gioco. Ghost ha un campo da gioco in cristallo trasparente e finiture in metallo.

*Ghost has an elegant and charming attitude; it is a precious presence with a subtle personality. It is not a "just look don't touch" object but it is a professional table football suitable for matches between both champions and lovers of this game. It has a transparent crystal made playing field and metal finishings.*



Ghost non è un oggetto da “guardare e non toccare” ma è un calciobalilla professionale

Ghost is not a “just look don’t touch” object but it is a professional table football









Ghost ha un portamento elegante e affascinante, è una presenza preziosa dalla personalità discreta

Ghost has an elegant and charming attitude; it is a precious presence with a subtle personality





# APOLLO 20

indoor/outdoor

design Basaglia + Rota Nodari



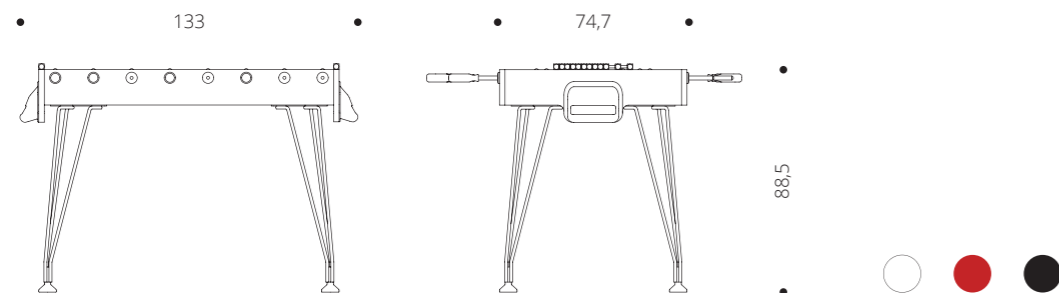

Ispirato al primo viaggio dell'uomo sulla luna, Apollo 20 è un calciobalilla perfetto per giocare all'aperto. La sua presenza in casa o in ufficio è discreta, fresca ed elegante. È snello e stabile allo stesso tempo, perfetto per scatenarsi nelle sfide più appassionante. Il campo da gioco è in multistrato idrofugo, mentre le gambe sono in tondino di metallo.

*Inspired by the first man's moon landing, Apollo 20 is a perfect outdoor table football. Its presence at home or at office is subtle, fresh and elegant. Apollo 20 is both lean and stable, ideal for having fun in passionate challenges. It has a waterproof plywood playing field and metallic rod legs.*









La presenza di Apollo 20 in casa o in ufficio è discreta, fresca ed elegante

*Apollo 20 presence at home or at office is subtle, fresh and elegant*





# CICLOPE

indoor/outdoor

design Basaglia + Rota Nodari



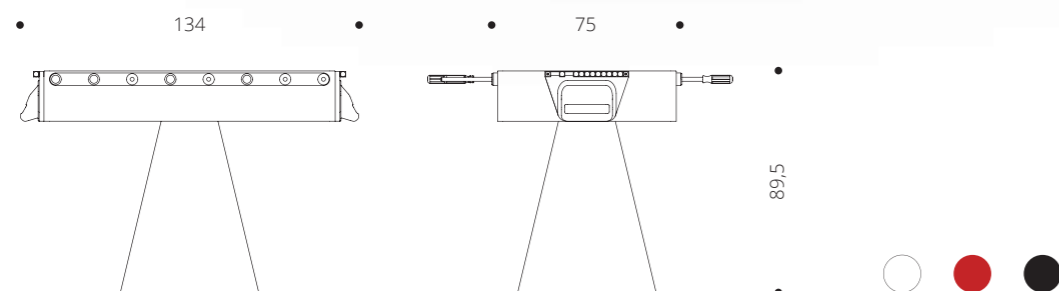

Ciclope ha una forma unica nel suo genere: sono state abbandonate le caratteristiche "gambe da tavolo" e adottata questa base conica, capace di dare stabilità ed eleganza al prodotto. I materiali utilizzati sono tutti resistenti agli agenti atmosferici, rendendolo adatto all'utilizzo sia per interni che esterni.

*Ciclope is unique of its kind: it gives up the usual concept of "4 leg table", adopting a truncated cone base instead. This is a great innovation, that is able to give stability and elegance to the product. The materials are resistant to external agents, making it appropriated to interior and exterior.*





Ciclope ha una forma unica nel suo genere: base conica, capace di dare stabilit  ed eleganza al prodotto

Ciclope is unique of its kind: cone base able to give stability and elegance to the product



Zenucchi shop  
Bergamo, Italy

Prodotti / Products: Ciclope,  
Ciclope Capri







**CICLOPE *Capri*** indoor/outdoor

design Basaglia + Rota Nodari



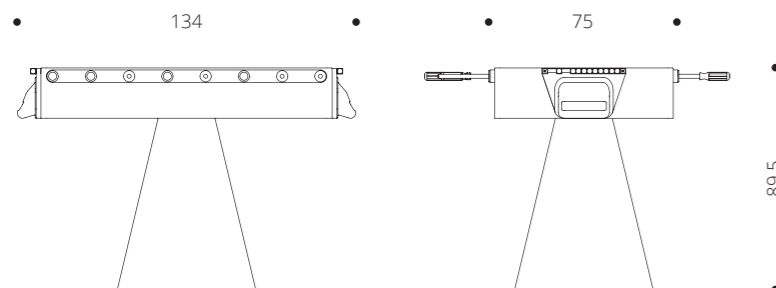

Capri, edizione speciale del calciobalilla Ciclope, è ispirato alle auto "spiaggina" degli anni '50 con la struttura azzurra, inserti in legno chiaro e il piano di gioco in vimini stampato. Un omaggio di FAS Pendezza a Napoli e al suo amore per il calciobalilla e il mare.

*Capri, a special edition of Ciclope football table, is inspired by the '50 italian car "spiaggina" with a light blue structure, light wooden inserts and a wicker texture printed on the game table. A tribute of FAS Pendezza to Naples and its love for football tables and sea.*



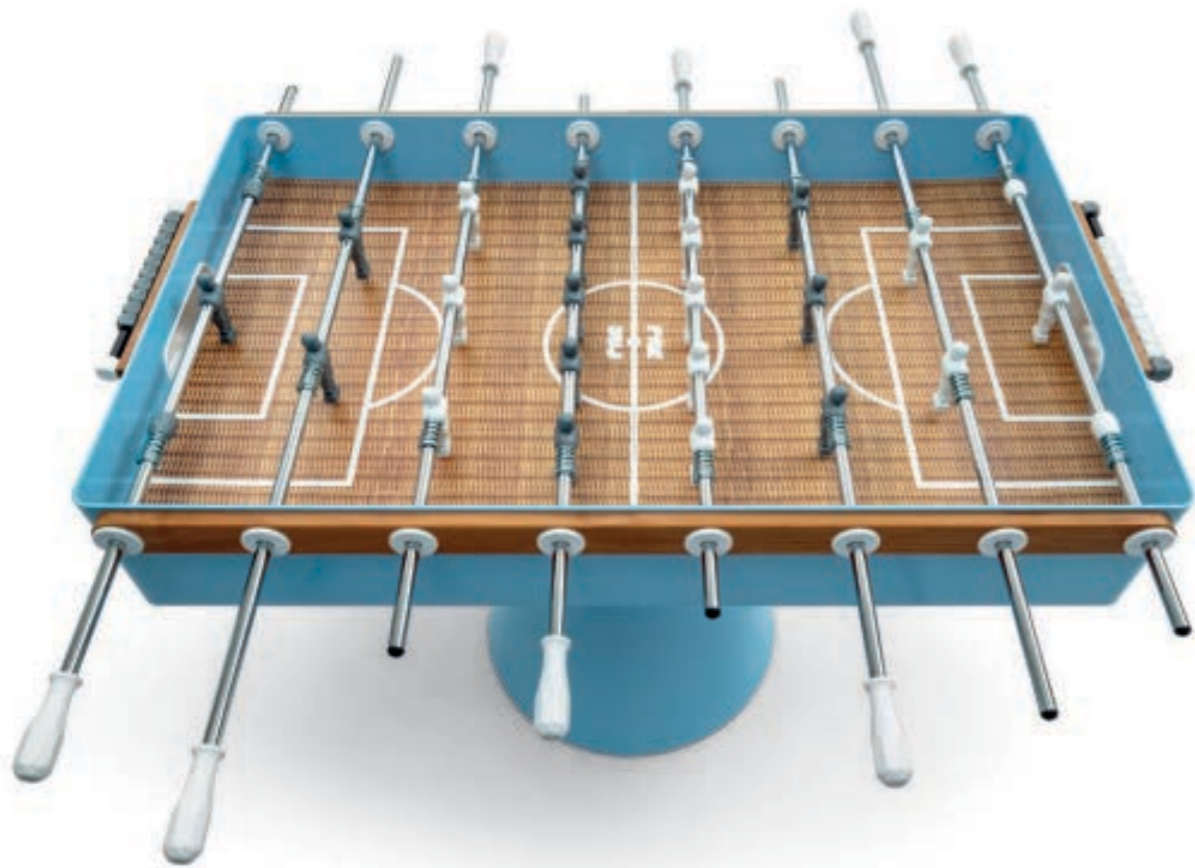

*Ciclope Capri, un omaggio di FAS Pendezza a Napoli e al suo amore per il calciobalilla e il mare*

*Ciclope Capri is a tribute of FAS Pendezza to Naples and its love for football tables and sea*

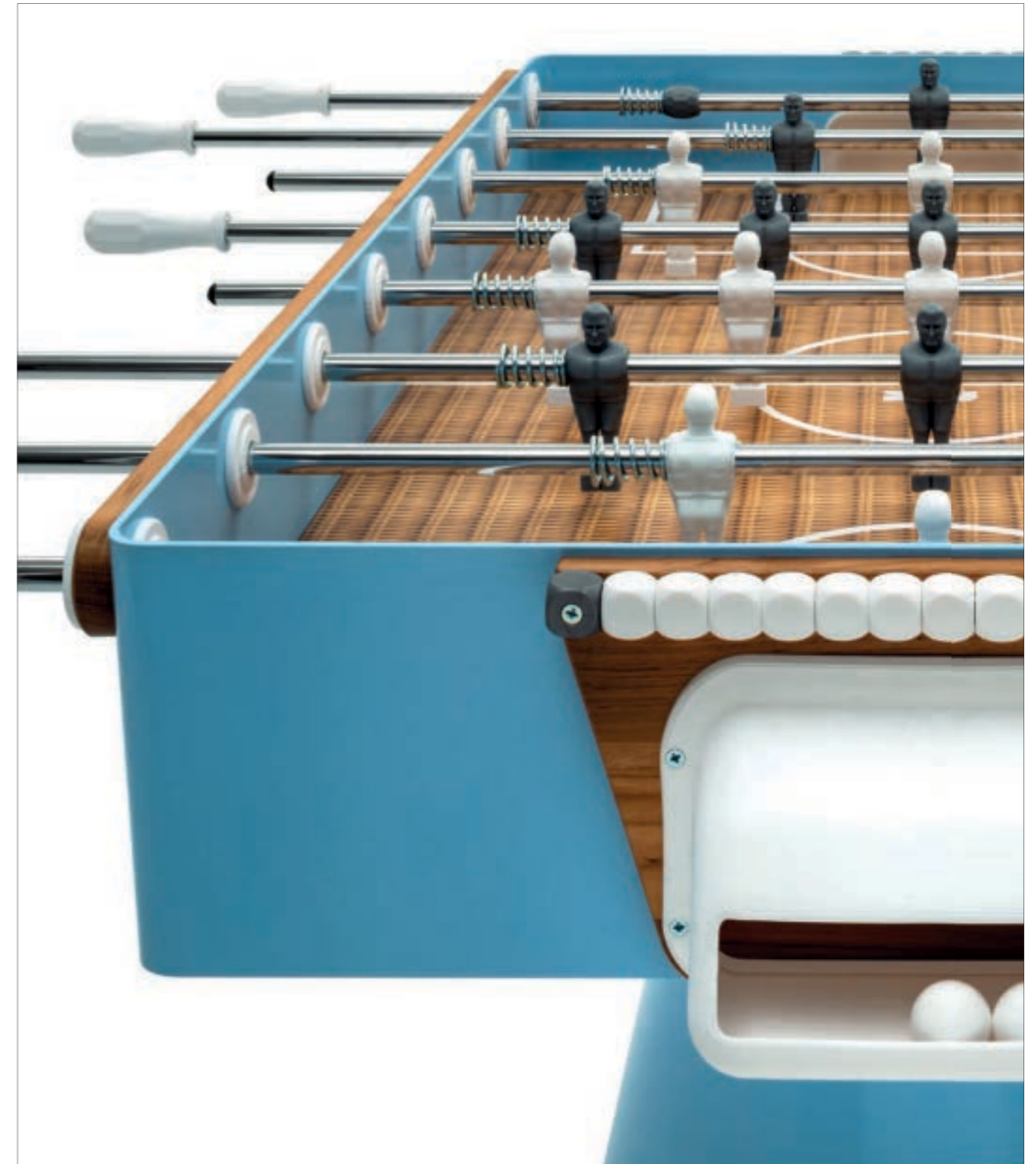



Dilmos shop  
Milan, Italy

Prodotti / Products:  
Ciclope Capri







# FIDO

indoor

design Basaglia + Rota Nodari



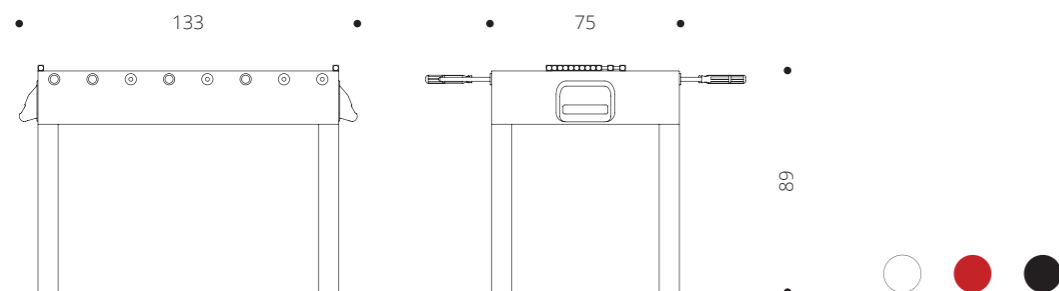

Il design del calciobalilla Fido si distingue per la purezza e l'eleganza delle linee. Semplice e ricercato in ogni dettaglio: le gambe a sezione quadrata sono in continuità con le sponde del piano da gioco. Fido si caratterizza per la finitura full-color: rossa, bianca o nera. Pratico ed affidabile è perfetto per gli spazi pubblici o privati come case e uffici.

*The design of the Fido table football stands out for the purity and elegance of the lines. Simple and refined in every detail: the square section legs are in continuity with the sides of the playing surface. Fido is characterized by the full-color finish: red, white or black. Practical and reliable, it is perfect for public or private spaces such as homes and offices*



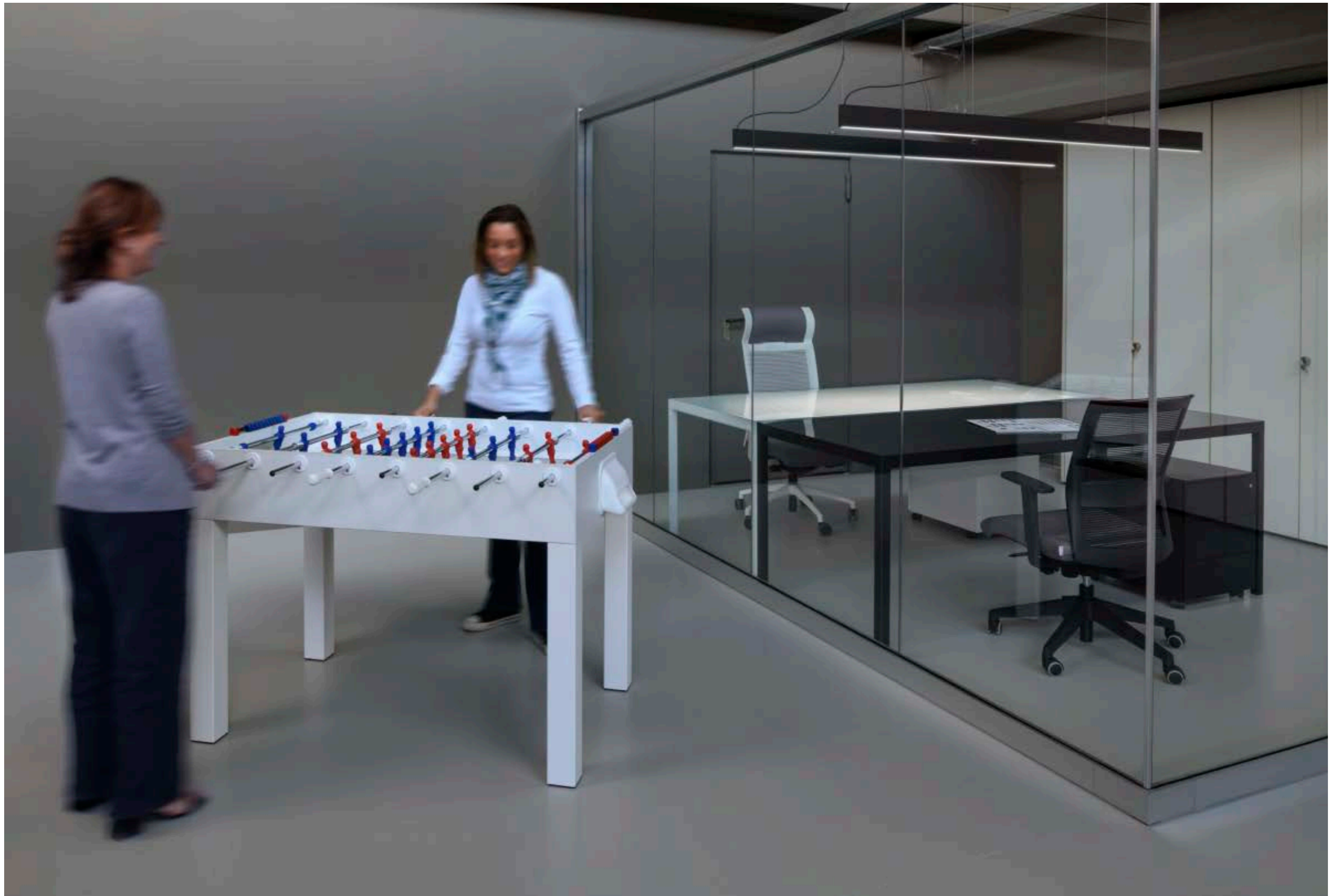





Pratico ed affidabile è  
perfetto per gli spazi  
pubblici o privati come  
case e uffici

*Practical and reliable,  
it is perfect for public or  
private spaces such as  
homes and offices*











# FLAMINGO

indoor

design Basaglia + Rota Nodari



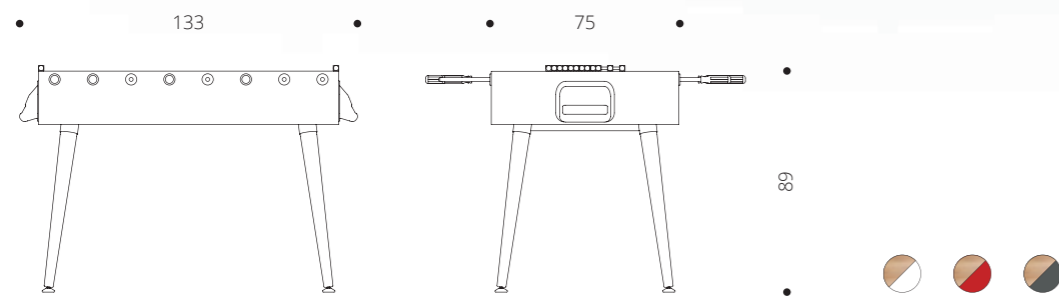

Flamingo è connotato da linee pulite con l'aggiunta di dettagli di pregio, come gli angolari e le gambe tornite in legno di faggio, inclinate per dare maggiore stabilità al gioco. Le colorazioni disponibili sono bianco, antracite e rosso, colori che rendono Flamingo un raffinato accessorio capace di introdursi elegantemente nell'ambiente domestico ed office.

*Flamingo is characterized by clean lines and precious details such as the angular and the turned beech wood legs. The legs are inclined in order to give more stability. The available colors are: white, anthracite and red. The colors make Flamingo a refined accessory able to adapt itself both domestic and office environments.*





**Flamingo** è connotato da  
linee pulite con l'aggiunta  
di dettagli di pregio

*Flamingo is characterized  
by clean lines and precious  
details*







**Vivienne Westwood shop**  
Milan, Italy

**Prodotto / Product:** Flamingo in versione rossa / *Flamingo in red version*

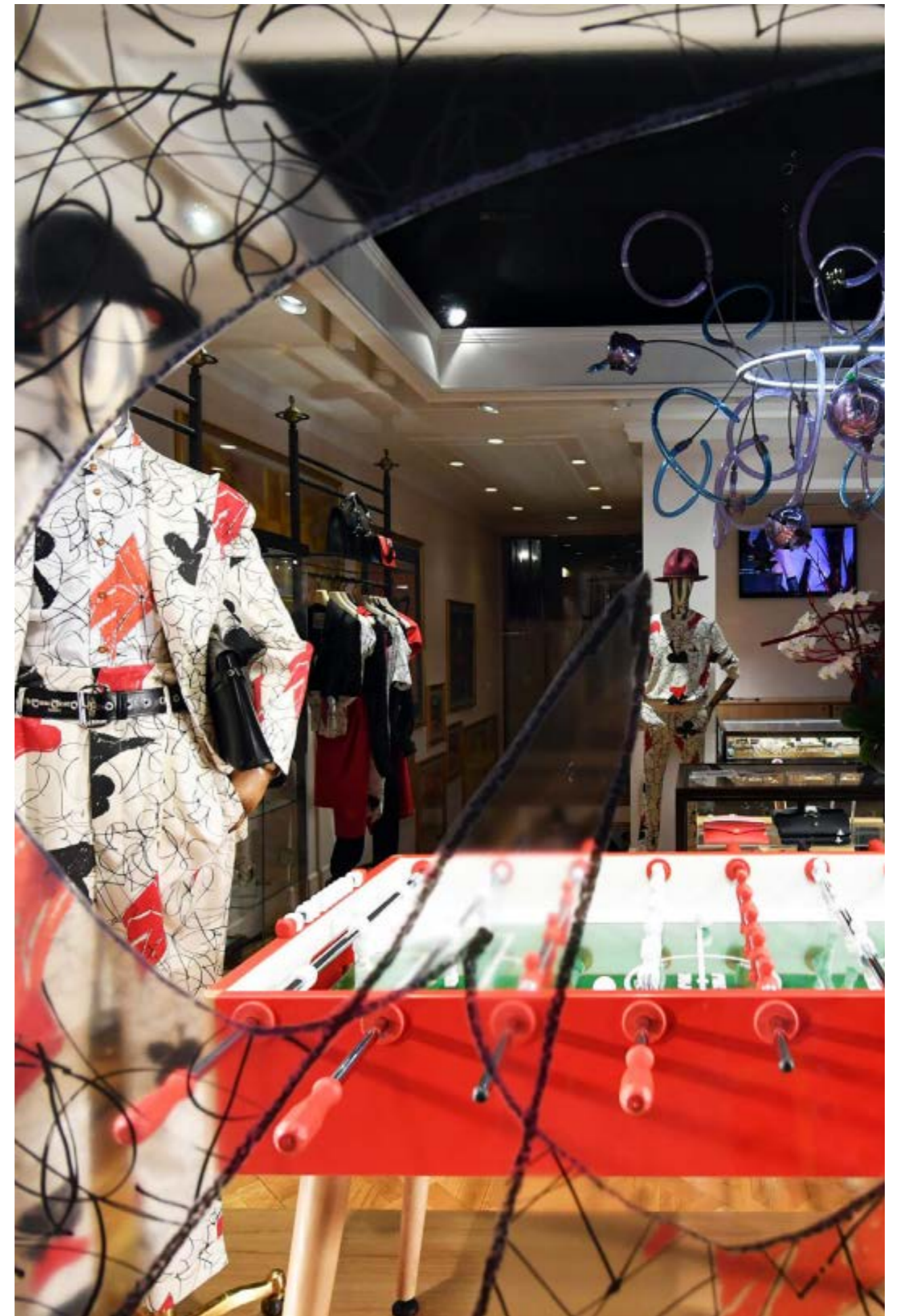





# TOUR '65

indoor

design Basaglia + Rota Nodari



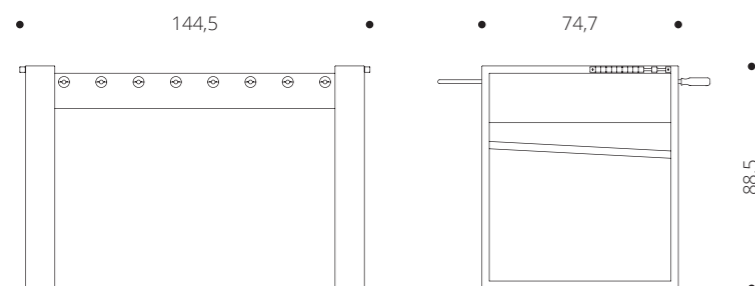

Tour '65 ha un design rigoroso che comunica stabilità ed eleganza. Si caratterizza per il futuristico sistema di recupero della pallina. È il primo realizzato con la boccia innovativa che si fissa con una sola vite. È disponibile nei colori bianco, rosso e nero e si adatta perfettamente negli ambienti domestici e in ufficio.

*Tour '65 has a rigorous design that communicates stability and elegance. It is characterized by the futuristic ball recovery system. It is the first made with the innovative bush that is fixed with a single screw. It is available in white, red and black and fits perfectly in home and office environments.*





Tour '65 si caratterizza  
per il futuristico sistema  
di recupero della pallina

*Tour '65 is characterized  
by the futuristic ball  
recovery system*











# ÉTOILE

indoor

design Basaglia + Rota Nodari



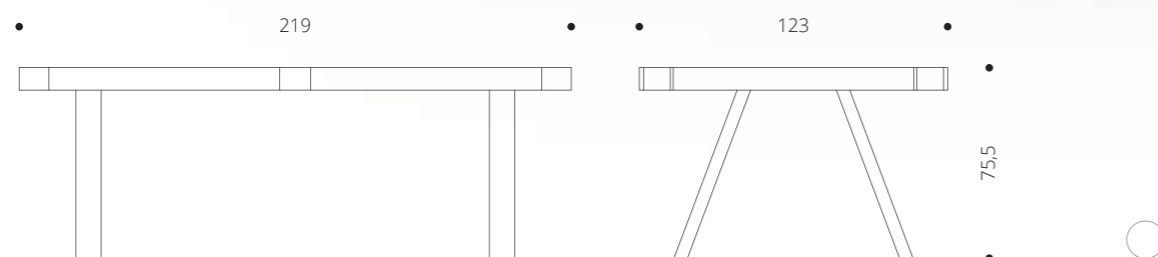

Forme innovative per un vero classico: il tavolo da biliardo Étoile è disegnato per stare sulle punte, come una prima ballerina. Gambe sottili e buche arrotondate, a formare un manufatto artistico non solo elegante ma anche funzionale. Disponibile con un doppio top, che va a coprire il campo da gioco quando non viene utilizzato, Étoile porta la giusta dose di innovazione ad un prodotto professionale.

*Innovative shapes for a real classic: the pool table Étoile is designed to be on pointe, like a Prima Ballerina. Thin legs and round billiard holes create an elegant but yet functional piece of art. It is available with a double top which covers the playing field when not in use. Étoile brings the right amount of innovation to a professional product.*





Il tavolo da biliardo **Étoile** è disegnato per stare sulle punte, come una prima ballerina

The pool table **Étoile** is designed to be on pointe, like a Prima Ballerina









# CUBISTA

indoor

design Basaglia + Rota Nodari



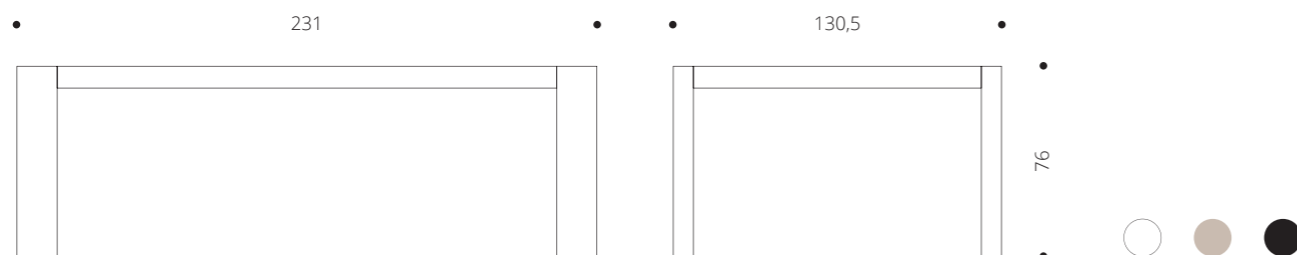

Un elegante tavolo contemporaneo cela al suo interno un segreto: un tavolo da biliardo. È sufficiente riporre il piano, scomposto in tre parti, in uno stipo a scomparsa ed il gioco è fatto! I sostegni del tavolo con i piedini regolabili integrati, sono fortemente caratterizzanti e ricordano le linee e le forme del movimento Cubista. Cubista è disponibile nei colori bianco nero e tortora.

*An elegant contemporary table conceals a secret inside: a pool table. It is enough to remove the tops, divided into three pieces, and put them into retractable supports and you're done! The supports of the table with integrated adjustable feet are strongly characterizing and recall the lines and shapes of the Cubist movement. Cubista is available in black, white and dove gray.*





Un elegante tavolo  
contemporaneo cela al  
suo interno un segreto:  
un tavolo da biliardo

*An elegant contemporary  
table conceals a secret  
inside: a pool table*









# CUBE

indoor

FAS editor



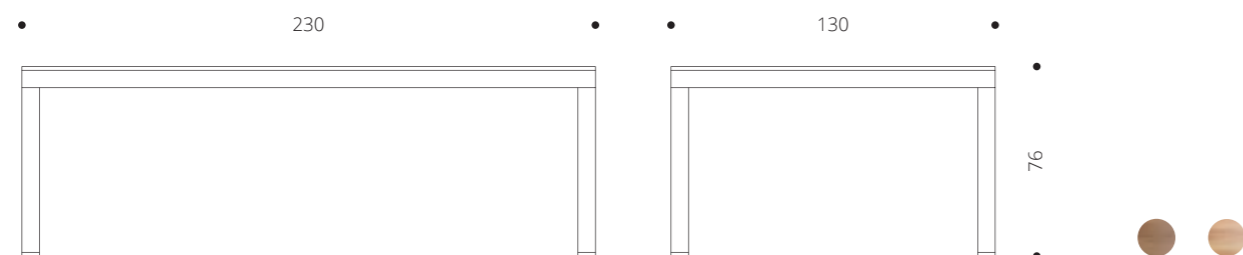

Cube è un tavolo da biliardo lineare, robusto e versatile. La struttura elegante e squadrata con l'aggiunta di un top superiore diventa un tavolo raffinato. FAS ha ridefinito l'idea di gioco ad alte prestazioni, trasformando il biliardo ricreativo in un arredamento raffinato versatile e divertente. Una combinazione perfetta di funzionalità e design Made in Italy.

*Cube is a linear, sturdy and versatile pool table. The elegant and squared structure becomes a refined table thanks to the addition of a top plane. FAS Pendezza has redefined the idea of a high-performance game, transforming the pool table into a refined, versatile and fun furniture. A perfect combination of functionality and Made in Italy design.*









**Cube** è una combinazione perfetta di funzionalità e design Made in Italy

*Cube is the perfect combination of functionality and Made in Italy design*





## LEGENDA

● Elemento di serie

\* Elemento optional

		CUBE 7	CUBISTA 7	ETOILE	
USO USE	Interno <i>Indoor</i>	●	●	●	
	Esterno <i>Outdoor</i>				
GAMBE LEGS	Lamiera piegata verniciata sp. 3mm / 160x80mm <i>3mm painted folded metal sheet / 160x80mm</i>		●		
	Scatolato metallico 100x50mm <i>Rectangular tube 100x50mm</i>			●	
	Scatolato metallico 70x70mm <i>Rectangular tube 70x70mm</i>	●			
CARATTERISTICHE FEATURES	Panno professionale <i>Professional cloth</i>	●	●	●	
	Gomma sponda professionale <i>Professional rubber cushions</i>	●	●	●	
	Piedino regolabile <i>Adjustable height feet</i>	●	●	●	
	Senza gettoniera <i>Free-play</i>	●	●	●	
	Stecche in dotazione <i>Cues included</i>	●	●	●	
	Billie numerate in dotazione <i>Numbered biliard balls included</i>	●	●	●	
	Triangolo in dotazione <i>Triangle included</i>	●	●	●	
	Gesso in dotazione <i>Chalk included</i>	●	●	●	
	Spazzola in dotazione <i>Brush included</i>	●	●	●	
	Pocket cestelli <i>Pockets</i>	●			
	Piano campo da gioco in ardesia a sezione unica <i>One section slate playing area</i>	●	●		
	Piano campo da gioco in legno a sezione unica <i>One section wood playing area</i>			●	
	Cestelli agli angoli <i>Drop pockets</i>	●	●	●	
	DIMENSIONI DIMENSIONS	Spessore piano campo da gioco in ardesia (mm) <i>Thickness slate playing area (mm)</i>	19	19	-
Spessore piano campo da gioco in legno (mm) <i>Thickness wood playing area (mm)</i>		-	-	19	
Altezza sponde (cm) <i>Height of cushion (cm)</i>		77 (+3)	77 (+3)	77 (+3)	
Misure campo da gioco (cm) <i>Size of playing area (cm)</i>		200x100	200x100	200x100	
Peso lordo / Peso netto (kg) <i>Gross weight / Net weight (kg)</i>		288 / 280	280 / 272	118 / 110	
IMBALLO PACKING	Cassone <i>Case</i>	Peso lordo (kg) <i>Gross weight (kg)</i>	54	54	54
		Dimensioni (cm) <i>Sizes (cm)</i>	235x133x17	235x133x17	235x133x17
		Nr. colli <i>Packages nr.</i>	1	1	1
	Gambe <i>Legs</i>	Peso lordo (kg) <i>Gross weight (kg)</i>	21	21	21
		Dimensioni (cm) <i>Sizes (cm)</i>	75x45x14	98x88x24	98x88x24
		Nr. colli <i>Packages nr.</i>	1	1	1
	Campo da gioco in ardesia <i>Slate playing area</i>	Peso lordo (kg) <i>Gross weight (kg)</i>	170	170	-
		Dimensioni (cm) <i>Sizes (cm)</i>	215x120x5	215x120x5	-
		Nr. colli <i>Packages nr.</i>	1	1	-
	Top <i>Top</i>	Peso lordo (kg) <i>Gross weight (kg)</i>	38	30	38
		Dimensioni (cm) <i>Sizes (cm)</i>	130x115x7	130x115x7	130x115x7
		Nr. colli <i>Packages nr.</i>	1	1	1
	Accessori <i>Accessories</i>	Peso lordo (kg) <i>Gross weight (kg)</i>	5	5	5
		Dimensioni (cm) <i>Sizes (cm)</i>	60x40x20	60x40x20	60x40x20
		Nr. colli <i>Packages nr.</i>	1	1	1





# DADA

indoor

design Basaglia + Rota Nodari



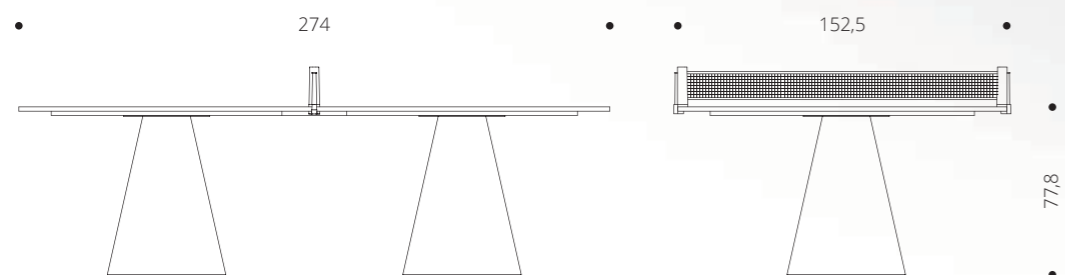

Dada è un tavolo da ping pong modulare, dove la flessibilità è il punto centrale. Due elementi separati, uniti dall'uso della rete, permettono lo svolgersi di avvincenti match, e allo stesso modo di accogliere 16 persone a sedere. Top in legno e struttura bianca, due basi coniche a sostegno del tavolo e una partita che aspetta di essere giocata.

*Dada is a modular table tennis where flexibility is the key issue. Two separate elements, joined together through the use of the net, allowing great matches to take place, as well as welcoming 16 people to sit and enjoy togetherness. A wooden playing field sustained by a white conical base and a memorable match who is waiting to be played.*





Dada è un tavolo da ping pong modulare, dove la flessibilità è il punto centrale

*Dada is a modular table tennis where flexibility is the key issue*











# ***DADA Outdoor*** outdoor

design Basaglia + Rota Nodari



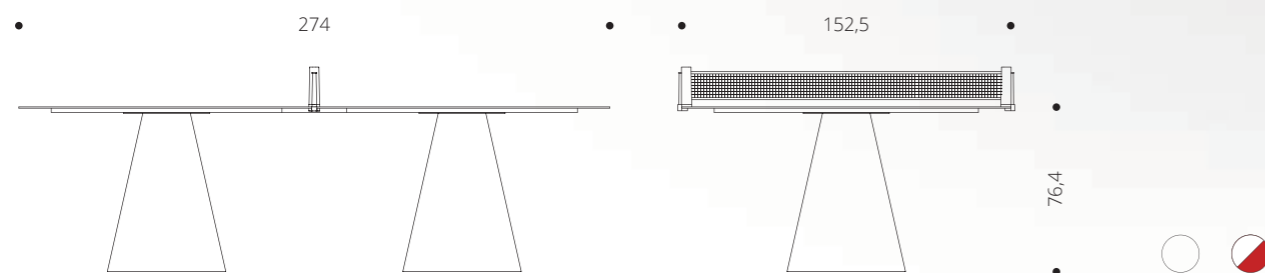

Dada si sostiene grazie a due basi coniche, che ridefiniscono la rappresentazione classica del ping pong. Una rivoluzione che porta con sé una divisione funzionale in due pezzi, che permette al tavolo di trasformarsi a bisogno in due distinti, accogliendo quattro persone l'uno. Perfetto negli spazi HORECA o quando si ha necessità di flessibilità, Dada, ispirato al Manifesto Dadaista reinterpreta i principi classici del tavolo da ping pong.

*Two conic bases reshape the classic representation of the table tennis, isn't it the first purpose of great design? A revolution that comes with a functional division in two elements, transforming, in case of need, the table tennis into two distinctive tables capable of welcoming eight people each. Inspired by the Dadaism Manifesto, Dada reinterprets the classic tenets of table tennis.*





Dada, ispirato al Manifesto Dadaista reinterpreta i principi classici del tavolo da ping pong

*Inspired by the Dadaism Manifesto, Dada reinterprets the classic tenets of table tennis*



Dada si sostiene grazie a due basi coniche, che ridefiniscono la rappresentazione classica del ping pong

*Dada hold itself by two conical bases, which redefine the classic representation of the table tennis*





# GRASSHOPPER

indoor

design Basaglia + Rota Nodari

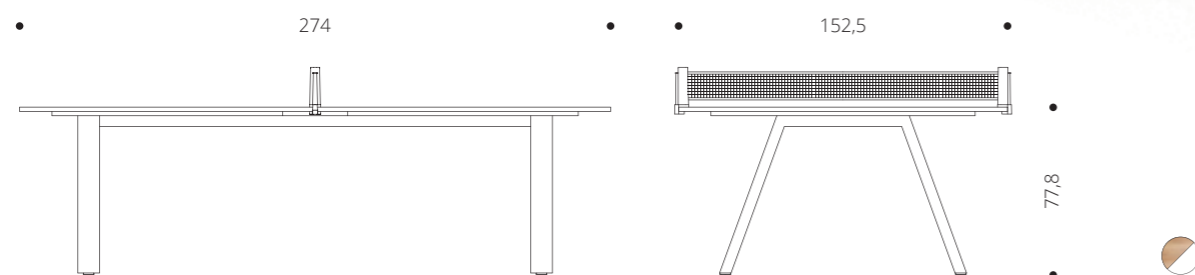

Grasshopper è un tavolo da tennis indoor con un finish legno. Le gambe sono agili e sottili, il top essenziale e dalle linee pulite, permettendone l'uso in diversi contesti. Le dimensioni del tavolo permettono di utilizzarlo anche nei momenti più conviviali, accogliendo fino a 12 persone. Grasshopper definisce un nuovo concetto di gioco, dove la convivialità riveste un ruolo centrale.

*Grasshopper is a table tennis, characterized by a wooden finish of the playing field. The legs are agile and thin, the top is essential and clean, allowing the table to be used in different environments. The width of the table makes it suitable to welcome twelve people: therefore, it can easily perform as a dining table for the most convivial moments. Grasshopper defines a new concept of play where togetherness plays a central role.*







Grasshopper definisce un nuovo concetto di gioco, dove la convivialità riveste un ruolo centrale

*Grasshopper defines a new concept of play where togetherness plays a central role*







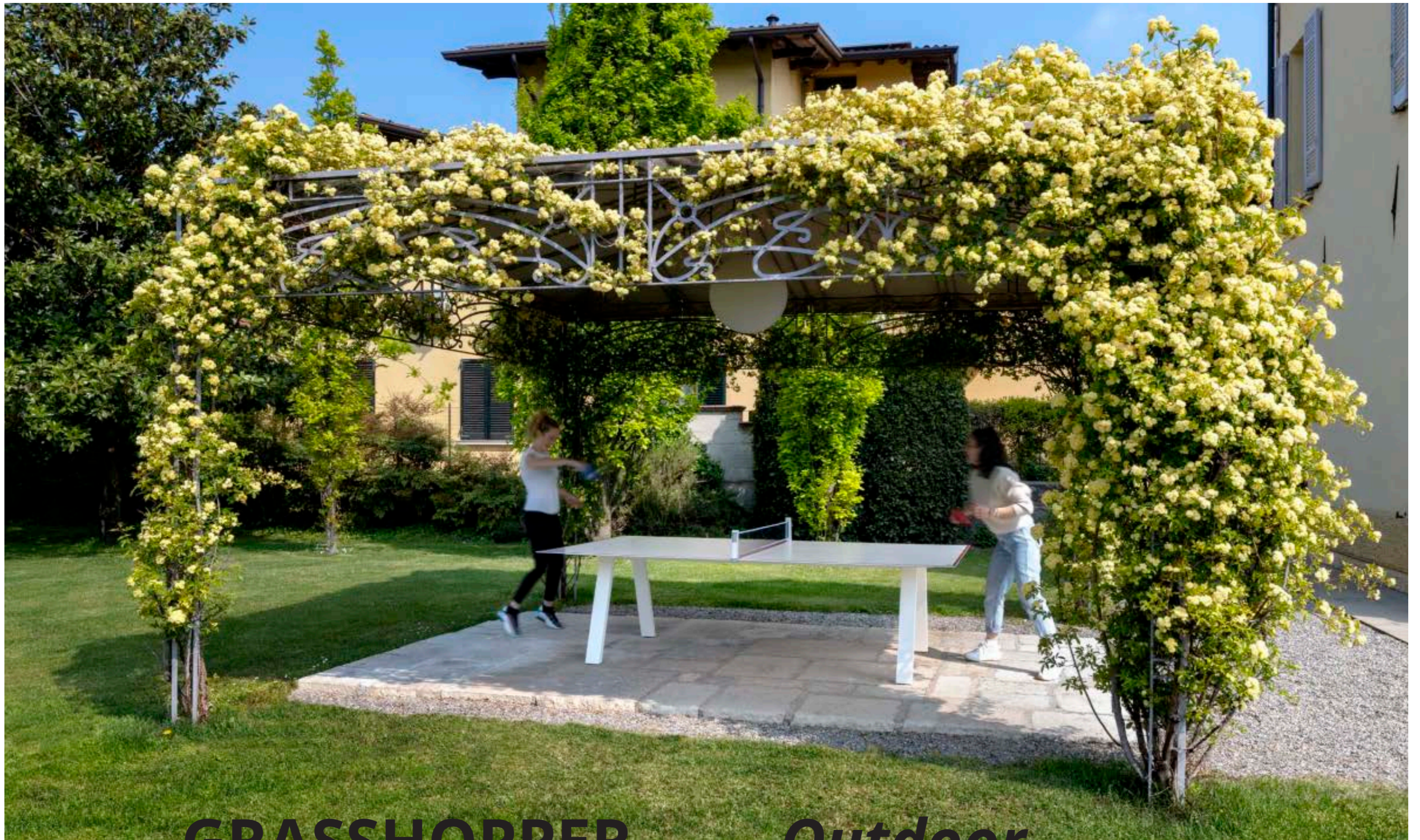

# GRASSHOPPER

# *Outdoor*

outdoor

design Basaglia + Rota Nodari



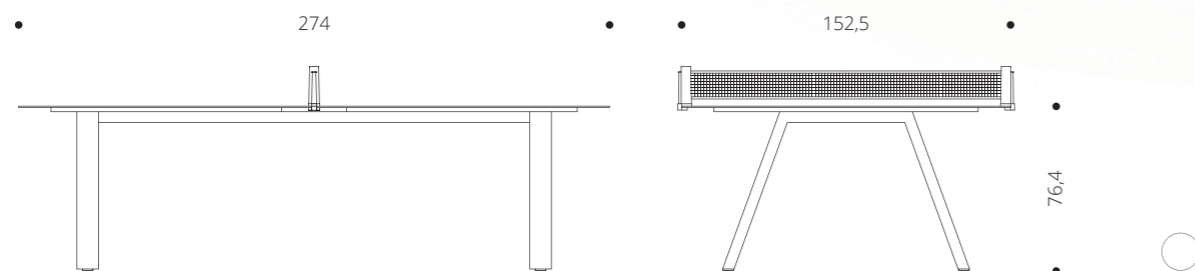

Piano del tavolo bianco e linee del campo rosse, una combinazione di design per la versione outdoor. Il tavolo da tennis bianco può trasformarsi facilmente in un tavolo da pranzo per la tua terrazza. Il logo FAS a garanzia di un design italiano di alta gamma e della resistenza del prodotto alle avversità atmosferiche. Grasshopper Outdoor è un prodotto capace di decorare i tuoi spazi esterni con stile.

*White playing field and red borders is the design combination of Grasshopper for outdoors. In case of need, the table tennis can be used as a contemporary terrace table. The FAS trademark certifies the high quality of this patented product, weather resistant and entirely made in Italy. Grasshopper Outdoor is a table tennis capable of decorating your outdoor spaces with style.*

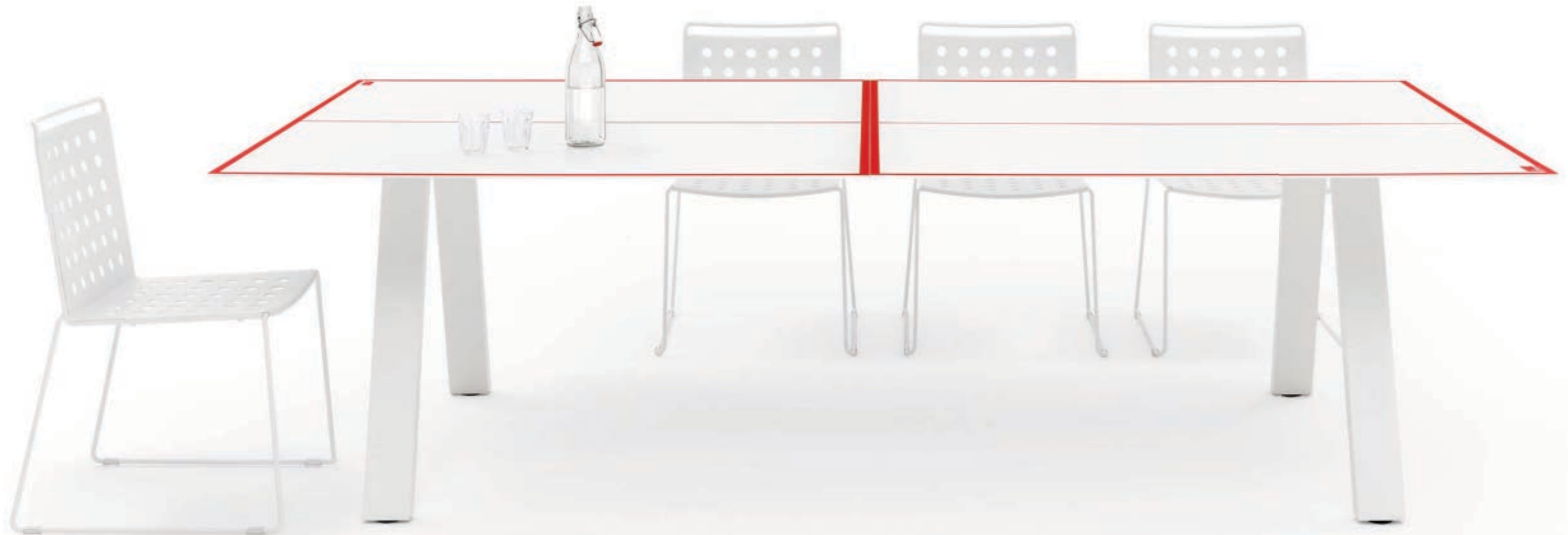

**Grasshopper Outdoor** è un  
prodotto capace di decorare i tuoi  
spazi esterni con stile

**Grasshopper Outdoor** is a table tennis  
capable of decorating your outdoor  
spaces with style





Piano del tavolo bianco e linee del campo rosse, una combinazione di design per la versione outdoor

*White playing field and red borders is the design combination for the outdoor version*





# SPIDER

indoor

design Basaglia + Rota Nodari



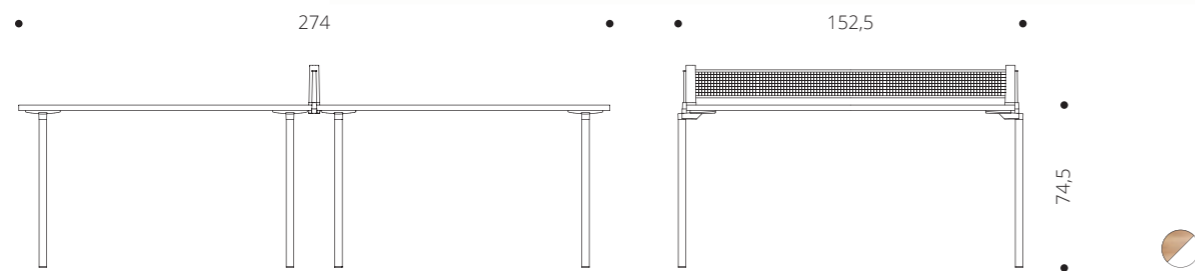

Spider è un tavolo da ping pong innovativo, capace di trasformarsi all'occorrenza in un tavolo conviviale e di scomporsi con pochi gesti grazie agli agganci tecnici nascosti al di sotto del piano di gioco. Ideale per l'uso domestico e per l'ambiente office, Spider è un oggetto di design capace di unire perfettamente svago e funzionalità.

*Spider is an innovative table tennis. With few easy steps it can be turned into a table and thanks to its hidden connections under the game top it can be easily compacted and stored. Ideal for home use and office environment, Spider is a design object that perfectly combines leisure and functionality.*



Spider è un oggetto di design capace di unire perfettamente svago e funzionalità

*Spider is a design object that perfectly combines leisure and functionality*





## LEGENDA

- Elemento di serie
- \* Elemento optional

		DADA	DADA OUTDOOR	GRASSHOPPER	GRASSHOPPER OUTDOOR	SPIDER	
USO USE	Interno <i>Indoor</i>	●	●	●	●	●	
	Esterno <i>Outdoor</i>		●		●		
GAMBE LEGS	Lamiera verniciata sp. 2mm <i>2mm painted metal sheet</i>	●	●				
	Gambe in tubolare metallico ø 35mm <i>Metallic tube legs ø 35mm</i>					●	
	Gambe in scatolato metallico 100x50mm <i>Rectangular tube legs 30x30mm</i>			●	●		
CARATTERISTICHE FEATURES	Piano campo da gioco in agglomerato di legno <i>Chipboard playing area</i>	●		●		●	
	Piano campo da gioco in HPL <i>HPL playing area</i>		●		●		
	Fornito da assemblare <i>Ready to assemble</i>	●	●	●	●	●	
DIMENSIONI DIMENSIONS	Spessore campo gioco in agglomerato di legno (mm) <i>Thickness chipboard playing area (mm)</i>	25	-	25	-	25	
	Spessore campo gioco in HPL (mm) <i>Thickness HPL playing area (mm)</i>	-	6	-	6	-	
	Altezza campo da gioco (mm) <i>Height of playing area (mm)</i>	750	750	750	750	750	
	Misure campo da gioco (cm) <i>Size of playing area (cm)</i>	152,5x274	152,5x274	152,5x274	152,5x274	152,5x274	
IMBALLO PACKING	Peso lordo / Peso netto (kg) <i>Gross weight / Net weight (kg)</i>		130 / 116	140 / 126	111,5 / 100	119,5 / 109	81,5 / 76
	Gambe <i>Legs</i>	Peso lordo (kg) <i>Gross weight (kg)</i>	60	60	-	-	11,5
		Dimensioni (cm) <i>Sizes (cm)</i>	87x63x63	87x63x63	-	-	80x26x20 80x26x20
		Nr. colli <i>Packages nr.</i>	2	2	-	-	2
	Gambe + telaio <i>Legs + frame</i>	Peso lordo (kg) <i>Gross weight (kg)</i>	-	-	40	40	-
		Dimensioni (cm) <i>Sizes (cm)</i>	-	-	145x88x22 205x12x7	145x88x22 205x12x7	-
		Nr. colli <i>Packages nr.</i>	-	-	2	2	-
	Campo da gioco <i>Playing area</i>	Peso lordo (kg) <i>Gross weight (kg)</i>	69	78	69	78	69
		Dimensioni (cm) <i>Sizes (cm)</i>	160x144x12	160x144x12	160x144x12	160x144x12	160x144x12
		Nr. colli <i>Packages nr.</i>	1	1	1	1	1
	Accessori <i>Accessories</i>	Peso lordo (kg) <i>Gross weight (kg)</i>	1,50	1,50	1,50	1,50	1,50
		Dimensioni (cm) <i>Sizes (cm)</i>	30x20x20	30x20x20	30x20x20	30x20x20	30x20x20
Nr. colli <i>Packages nr.</i>		1	1	1	1	1	



**Art Director:**  
Alberto Basaglia

**Concept and Graphic design:**  
Alberto Basaglia Natalia Rota Nodari Architetti Associati

**Photo:**  
Carlos & Dario Tettamanzi

**Print:**  
Grafiche Gemma

**Si ringrazia / Thanks to:**  
Agenzia T&T / [agenziatet.it](http://agenziatet.it)  
Filippi 1971 / [filippi1971.com](http://filippi1971.com)  
Viganò Office / [viganoooffice.it](http://viganoooffice.it)



**FAS PENDEZZA S.r.l.**

Via Provinciale, 671 - 24020 Villa d'Ogna (BG) - Italy  
Tel. +39 0346 21164 • Fax. +39 0346 23134  
[info@faspandezza.it](mailto:info@faspandezza.it) • [www.faspandezza.it](http://www.faspandezza.it)



**FAS PENDEZZA S.r.l.**

Via Provinciale, 671 - 24020 Villa d'Ogna (BG) - Italy  
Tel. +39 0346 21164 • Fax. +39 0346 23134  
info@faspandezza.it • www.faspandezza.it